

SEAVIEW///

ELEVATE YOUR ELECTRONICS

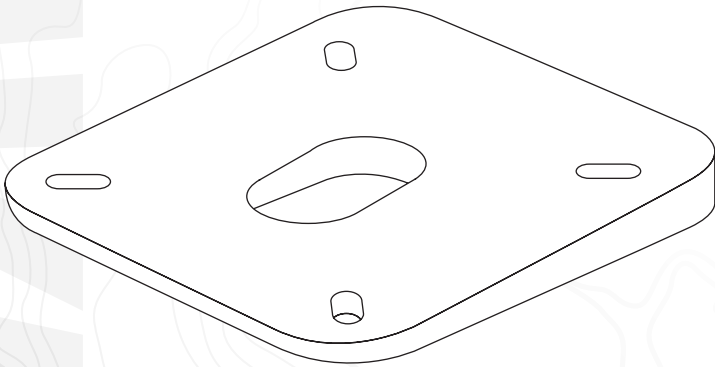

INSTALLATION INSTRUCTIONS

For Seaview Direct Mount Wedges:

***RW4-1, RW4-2, RW4-3, RW4-4
RW4-5, RW4-6, RW4-7***

PARTS INCLUDED

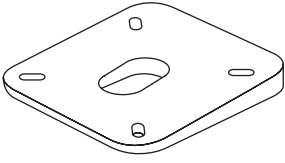

RW4-1

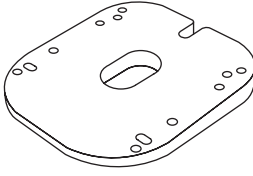

RW4-2

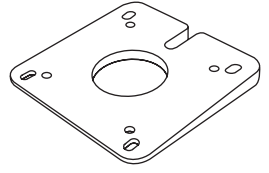

RW4-3

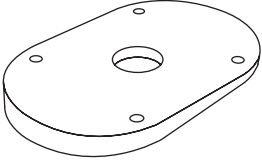

RW4-4

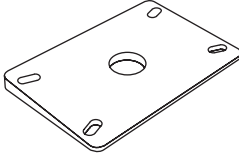

RW4-5

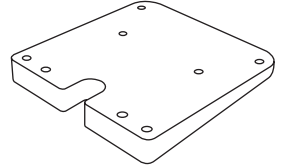

RW4-6

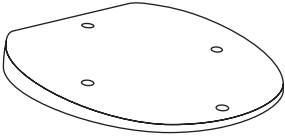

RW4-7

TOOLS NEEDED

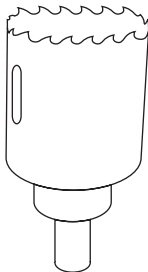
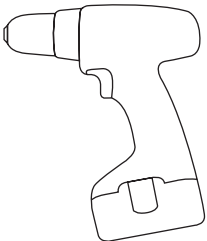
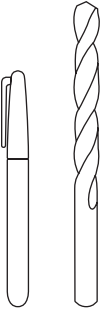

1 Place the wedge onto the mounting surface and mark all the holes.

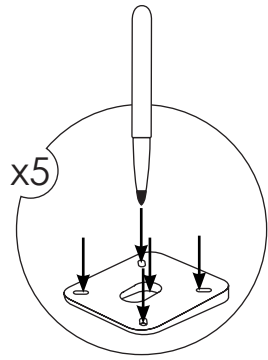

2 Drill the four bolt holes.

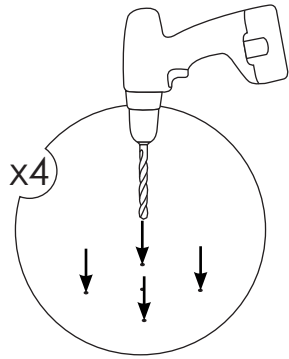

3 Use a hole saw to drill a center hole to run cables through.

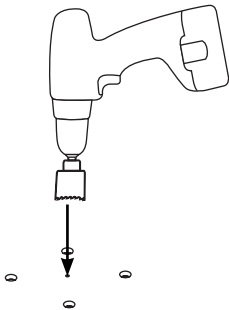

4 Apply marine adhesive sealant to the bottom of the wedge. Then mount your radar to the wedge and secure into place.

