

SITEX[®]

MARINE ELECTRONICS

AUTOPILOT DRIVE SOLUTIONS 2011



PRECISION PRODUCTS FOR POWER AND SAIL BOATS





Since 1975, SI-TEX Marine Electronics has been a world leader in marine electronics and innovation and have long been the choice of professionals around the world. SI-TEX offer a full line of premium quality marine electronics systems including radars, navigation systems, VHF radios, fishfinders, autopilots, AIS and more, products that have proven their performance and reliability in the harsh marine environment.

While we offer a complete product line covering a wide range of recreational and light commercial applications, we also provide unmatched personal service and customer support. We believe every customer is family, so we strive to provide the best after sales support in the industry.

Octopus products are backed by 25 years of continuous experience in the design and manufacture of marine steering systems. Since their introduction in 1984 Octopus products have been used on thousands of commercial vessels and yachts using virtually every make of autopilot.

Autopilot manufacturers worldwide recommend and use these products as the muscle to move rudders via their own Autopilot control systems.

Octopus and SI-TEX are committed to providing the best solutions with the simple aim of making the experience of boating fun and trouble free.

OCTOPUS PRODUCTS - A WORLD LEADER IN THE DESIGN AND MANUFACTURE OF AUTOPILOT DRIVE UNITS

WHY OCTOPUS?

- Over 25 Years experience designing and producing cutting-edge autopilot drive solutions for trouble free navigation
- Complete product solutions for all boat types (leisure and commercial) up to 120ft in length
- Powerful, efficient motors give maximum thrust with minimal power draw
- Unique mechanical and hydraulic designs for simple installation
- Unique hydraulic pumps for accurate positioning
- Unique, low drag mechanical and hydraulic linear drives for "best feel on the wheel"
- Integrated units, versatile and easy to install
- Commitment to continuous development and improvement

CONTENTS

Mechanical Dashboard Drive Type S/T	3
Mechanical Remote Drive - System Packs	4
Hydraulic Reversing Pumps	5
Hydraulic Continuous Running Pumps	6
Mechanical Linear Drive Type RS.....	7
Hydraulic Linear Drives.....	8
Hydraulic Linear Drives (Custom Solutions).....	9
Linear Hydraulic Drive - Application Guide.....	10
Mechanical Drive - Accessories.....	11
Hydraulic Drive - Accessories	12

MECHANICAL DASHBOARD DRIVE TYPE S/T

PROFESSIONAL SOLUTIONS FOR STERN DRIVE & OUTBOARD ENGINES

These drives are a professional solution replacing the manual helm with a manual helm/autopilot drive combination. No unsightly autopilot drive is seen behind the steering wheel in front of the dash.

SUITABLE FOR CABLE STEERED BOATS UP TO 35FT IN LENGTH!



UNIQUE AUTOPILOT DRIVES FOR CABLE STEERED BOATS

TYPE S BEHIND THE DASH DRIVE MDMSW

The Straight shaft drive unit replaces the manual drive used on cable steered boats and is mounted directly behind the dash.

The drive is directly compatible with the Morse 290 steering helm but comes with its own bezel kit and can be retrofitted in most installations using the cable and steering wheel from the manual steering helm on the boat. The dealer installation guide can be downloaded from our website which gives all the necessary information. See page 11 for optional accessories.



TYPE T TILT BEHIND THE DASH DRIVE MDTPW

This drive unit replaces a manual Tilt drive and is mounted directly behind the dash, but still allows the angle of the steering wheel to be changed. It uses the front end from Teleflex SH91800 (not supplied).

See page 11 for optional accessories.



OPTIONAL RUDDER FEEDBACK UNIT

Typically one of the most complex and time-consuming aspects of autopilot installation is fitting the rudder feedback unit and ensuring that the geometry matches the full range of rudder movement. The solution is an integrated rudder feedback unit that directly mounts to the drive unit itself.

A range of rudder feedback units are compatible with all major autopilot brands and models - see page 11 for the selection chart.

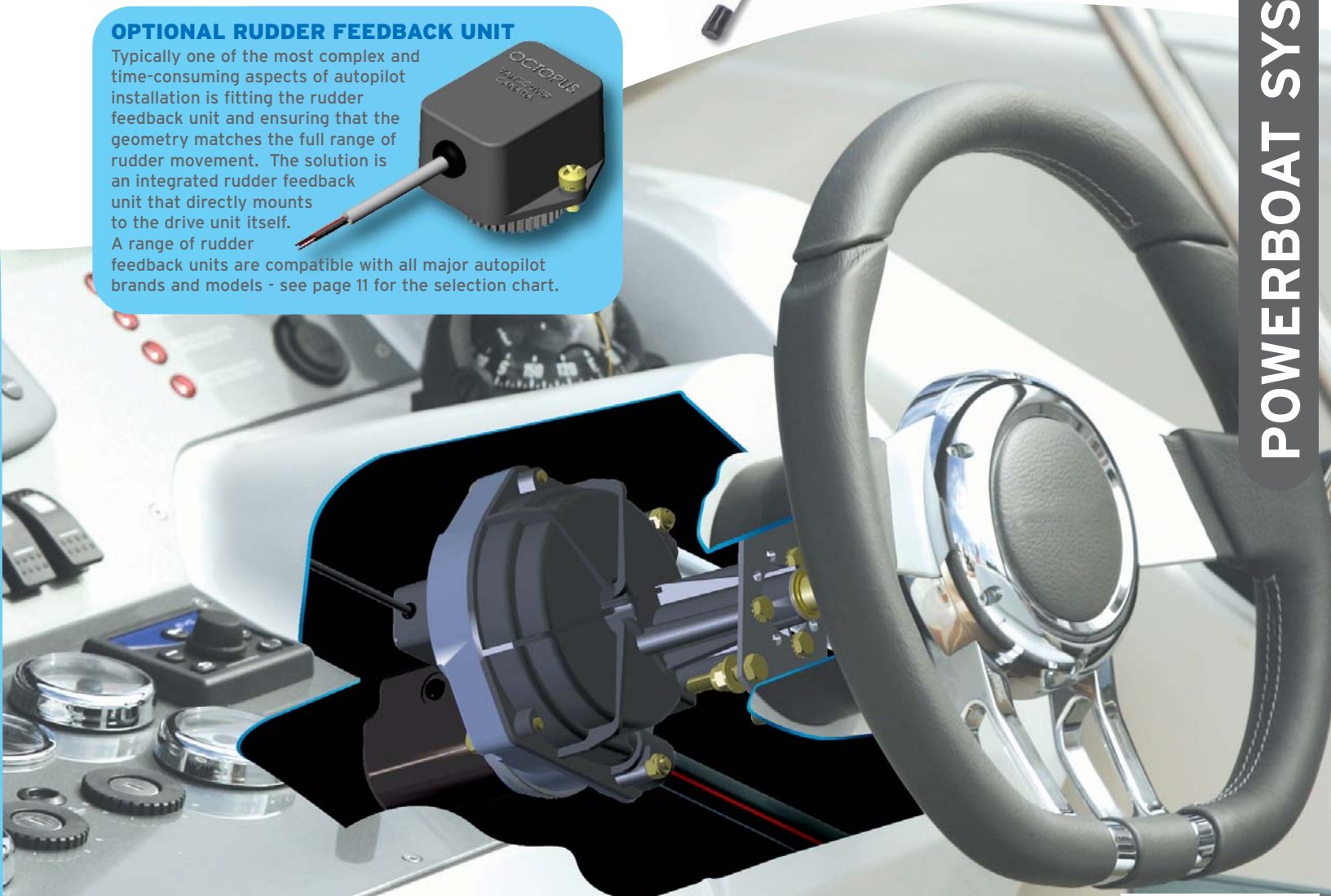
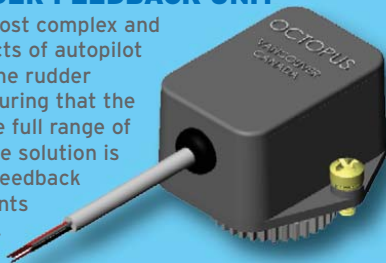

POWERBOAT SYSTEMS

MECHANICAL REMOTE DRIVE - SYSTEM PACKS

ONE DRIVE, ALL BOATS

The revolutionary Type R Remote Drive System makes selection and installation simple - one standard drive unit is suitable for all boat types, whether it's a powerboat with outboard, sterndrive or inboard steering as well as sailboats.

EVERYTHING YOU NEED IN THE BOX

Now Octopus have made things even easier with the new Remote Drive Autopilot Packs - everything needed for fitting is supplied in one box, including steering cable and installation kit. To specify, simply choose the appropriate engine make and drive system.

OPTIONAL RUDDER FEEDBACK UNIT

With an autopilot installation, typically one of the most complex and time-consuming aspects is fitting the rudder feedback unit and ensuring that the geometry matches the full range of rudder movement.

The Type R system gets around this problem with its optional integrated rudder feedback unit that directly mount to the drive unit itself. A range of rudder feedback units are compatible with all major autopilot brands & models - see page 11 for the selection chart.



Optional Rudder Feedback Unit

UNIVERSAL SOLUTION

One drive fits most engine and steering types.

EASY TO BUY

Everything you need in one box - drive unit, cable, installation kit.

EASY TO FIT

Simple to mount installation kits and optional integrated rudder feedback make for easy fitting.

COMPACT

The remote drive unit has a tiny 0.25ft² footprint and can be mounted in the most convenient location on your boat.

RELIABLE & SAFE

Proven, tested design. The drive unit features a manual override without having to disengage the autopilot first.

COMPATIBLE WITH YOUR PILOT

Compatible with all major autopilot brand electronics.

SELECTION GUIDE

PART No.	DRIVE SYSTEM	ENGINE MAKE / MAX DISPLACEMENT
MDRESYS-A	Sterndrive	Mer cruiser 1994+/ Volvo Gasoline
MDRESYS-B	Sterndrive	Mer cruiser 1983-93/ Volvo Diesel
MDRESYS-C	Outboard	Yamaha 70hp+
MDRESYS-D	Outboard	Mercury, Mariner, Suzuki
MDRESYS-E	Inboard/Sail	13,200lbs (6t) 32ft (9.75m)



ONE DRIVE FITS ALL!

OUTBOARD ENGINES	
Engine Type	Part Number
Yamaha 70hp+	MDRESYS-C
Mercury, Mariner, Suzuki	MDRESYS-D

STERNDRIVES	
Engine Type	Part Number
Mer cruiser 1983-93	MDRESYS-B
Mer cruiser 1994-	MDRESYS-A
Volvo Diesel	MDRESYS-B
Volvo Gasoline	MDRESYS-A

INBOARD ENGINES	
Boat Size	Part Number
Up to 32ft (9.75m)	MDRESYS-E
13,200lbs (6,000Kg) displacement	

SAILBOATS	
Boat Size	Part Number
Up to 32ft (9.75m)	MDRESYS-E
13,200lbs (6,000Kg) displacement	

See p7 for larger drive model suitable for inboard/sailboats up to 38ft/15,500lbs

HYDRAULIC REVERSING PUMPS

THE BENEFITS OF AN OCTOPUS PUMP

RELIABLE

Octopus pumps use the patented piston technology and have only three moving parts. Thousands of these pumps are in service around the world and have established a reputation of reliability.

SAVE ON INSTALLATION COSTS

A professional installation should always have a method of isolating the pump from the steering system - Octopus pumps feature inbuilt shut off valves in the pump manifold.

TWICE THE POWER

The unique Octopus piston pump delivers over twice the hydraulic output per watt of input than a standard hydraulic gear pump.

HALF THE CONSUMPTION

Gear pumps leak oil between the gears, while a piston (such as used in car engines) does not. This means the piston pump will place the cylinder ram exactly where it is required, positioning the rudder accurately. This gives far sharper steering, reducing unnecessary course corrections meaning battery consumption on Octopus pumps is up to half that of other pumps.

**ONLY
THREE
MOVING
PARTS!**

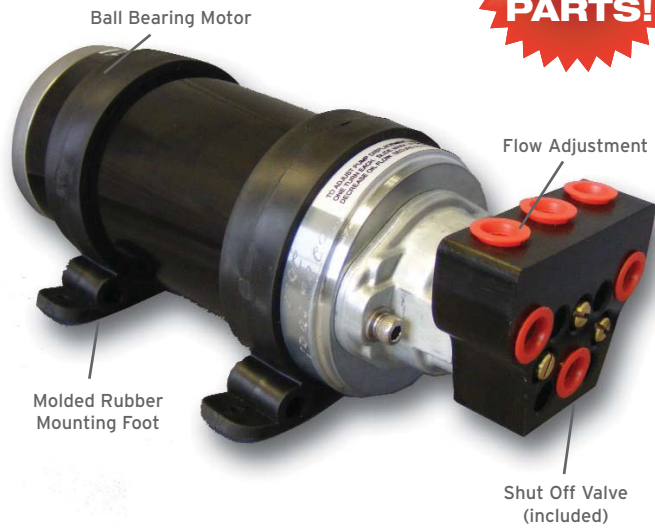

ADJUSTABLE FLOW PUMPS OFFER A PROFESSIONAL SOLUTION TO MATCHING AN AUTOPILOT PUMP TO A STEERING SYSTEM

ADJUSTABLE FLOW RATE

A pump that does not have variable flow (unless dedicated to a range of cylinders such as our fixed 0.8L pump) will be operating too fast or too slow in 90% of cases. Autopilot manufacturers get around this problem by adjusting the output to the pump to compensate. However, this either forces the pump to operate for longer periods of time which increases power consumption and wear on the parts, or the pump will operate at high pressure for short periods of time - also putting unnecessary strain and wear on the system.

Octopus Variable Flow Reversing Pumps precisely control the speed of the ram, reducing unnecessary battery consumption, pressure, strain and wear on the hydraulic system.

PINPOINT ACCURACY

Leading autopilot manufacturers choose Octopus pumps for their non RFB pilot systems which do not have a Rudder Feedback unit. Previously, slop in the system caused by gear leakage meant that a Rudder Feedback unit was necessary to tell the pilot the exact rudder position. As Octopus pumps will always bring the ram back to the required position the Rudder Feedback unit is not required, which also greatly simplifies installation.

GETTING THE BEST STEERING PERFORMANCE FOR THE BOAT

The flow rate of the pump can be set to get the best 'hard over time' (cylinder ram speed) for the particular boat. There is a simple equation to calculate the hard over time:

$$\text{HARDOVER TIME} = \frac{\text{CYLINDER (RAM) CAPACITY} \times 60}{\text{FLOW RATE}}$$

EXAMPLE

A boat has a 200cc steering cylinder (ram) and a 12 volt system. So either the OCTAF1012 or the OCTAF1212 would be suitable (see table below left). For this example we are using the OCTAF1212 which has a minimum flow rate of 600cc/min and a maximum flow rate of 1200cc/min:

$$\text{MIN HARDOVER TIME: } \frac{200 \times 60}{600} = 20 \text{ sec}$$

$$\text{MAX HARDOVER TIME: } \frac{200 \times 60}{1200} = 10 \text{ sec}$$

The flow rate on the pump can be adjusted so that the hard over time is between 10 & 20 seconds - select which is most suitable for this particular boat.

SELECTION GUIDE

PART No.	FLOW RATE (Adjustable)	CYLINDER RANGE	VOLTAGE	MAX CURRENT	AVERAGE CURRENT
1012	500cc-1L/min	150-300cc (9-18in ³)	12v	19A	4-6A
1024	500cc-1L/min	150-300cc (9-18in ³)	24v	10A	2-3A
1212	600cc-1.2L/min	180-360cc (11-22in ³)	12v	19A	4-6A
1224	600cc-1.2L/min	180-360cc (11-22in ³)	24v	10A	2-3A
2012	1.0-2.0L/min	245-500cc (15-30in ³)	12v	22A	6-8A
2024	1.0-2.0L/min	245-500cc (15-30in ³)	24v	11A	3-4A



POWERBOAT SYSTEMS

HYDRAULIC CONTINUOUS RUNNING PUMPS

POWER AND CONTROL - FULLY INTEGRATED

Octopus CR (Continuous Running) pumps are used in larger, heavy duty hydraulic steering systems where normal reversing pumps cannot be used. The pumpset has a motor driving a precision pump. The pump includes an inbuilt hydraulic fluid reservoir and a tandem center solenoid control valve which directs hydraulic fluid flow to the steering cylinder. When the autopilot makes a correction the appropriate solenoid coil diverts the hydraulic fluid into the steering system in the required direction.

All Octopus CR pumpsets are completely integrated with custom manifolds and no complicated external pipes and fittings to break or leak.

Available with AC or DC motors.



CRA PUMPSETS

CRA Pump sets are DC motor driven pumps for use on larger yachts and small commercial vessels. These pump sets can be used on steering cylinders up to 60cu in (1000cc) in volume.

Unlike reversing pumps, which are rarely capable of delivering full steering pressure above 1/2 gallon/min (2000 cc/min) flow rate, CRA pumps deliver over 500 psi (35 bar) and are very economical in power consumption.

As the solenoids only draw 12watts, the pump can be driven directly from the autopilot course computer without a relay, significantly reducing the autopilot cost.

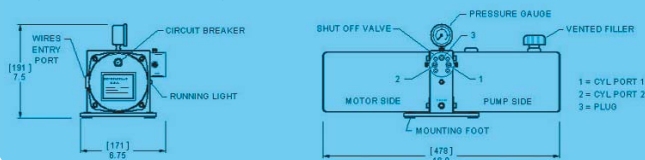

CRB PUMPSETS

CRB pumpsets are DC or AC motor driven pumps for larger yachts and commercial vessels. They can be used with steering cylinders up to 200cu in (3500cc).

- Adjustable pressure relief valve and pressure gauge
- Available as a simple pump unit, a motor and reservoir combination to replace an engine driven pump or fitted with a direction solenoid valve
- Adjustable flow control option
- Dual speed option
- Heavy-duty ball bearing electric motors
- Mechanical seal between the motor and pump (rather than the usual lip seal) ensures long service life without "grooving" the shaft
- Large capacity reservoir for cool running in all climates

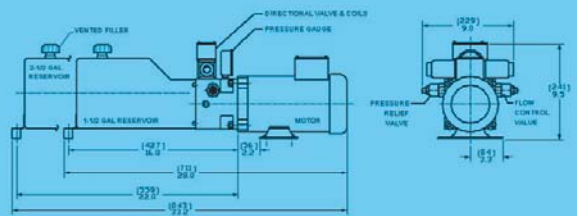

CRA PUMPSET ORDER CODE

CRA FF - VV - P - F - R

Flow (FF)	Voltage (VV)	Options
02 - 2000cc/min (0.50gpm)	12 - 12v DC	P - Pressure Gauge
03 - 3000cc/min (0.75gpm)	24 - 24v DC	F - Flow Control
04 - 4000cc/min (1.00gpm)		R - Relief Valve

eg CRA02-12-F-R = 2000cc/min, 12v with flow control & relief valve

CRB PUMPSET ORDER CODE

CRB FF - VVV - SS - O

Flow (FF)	Voltage (VVV)	Solenoid Voltage (SS)	Options (O)
04 - 4000cc/min (1.00gpm)	12 - 12v DC	12 - 12v DC	A - Basic Unit
06 - 6000cc/min (1.50gpm)	24 - 24v DC	24 - 24v DC	B - Single Speed
08 - 8000cc/min (2.00gpm)	32 - 32v DC	32 - 32v DC	+ Flow Control
10 - 10000cc/min (2.80gpm)	11S - 110/220v AC	11 - 110v AC	C - Two Speed
13 - 13000cc/min (3.50gpm)	(Single Phase)	22 - 220v AC	+ Flow Control
	22T - 220/440/575v AC		
	(Three Phase)		

eg CRB06-11S-22-C = 6000cc/min, 110/220v single phase with 220v AC solenoid, two speed with flow control



MECHANICAL LINEAR DRIVE TYPE RS

ALSO
SUITABLE
FOR INBOARD
ENGINE POWER
BOATS!

COMPACT AND CONVENIENT SOLUTION

The Octopus Remote Sailboat Drive System makes it easy and economical to install an autopilot on light displacement Sailboats steered with mechanical cable or tiller. The drive is very responsive and has little feedback resistance when in 'Standby' Pilot mode making it very suitable for racing yachts.

The linear drive connection kit can be fitted into very small spaces which makes it ideal for the smaller to mid-sized modern yachts which have limited space to fit drive units.

Recommended for Yachts up to 38ft (11.5m) with a maximum displacement of 15400 lbs / 7000 kg.

EVERYTHING YOU NEED IN THE BOX

We've made things even easier with the RS Sailboat Drive Autopilot Packs - everything you need to install the drive is supplied in one box, including steering cable and installation kit.

INTEGRATED RUDDER FEEDBACK UNIT

With an inboard pilot installation, typically one of the most complex and time-consuming aspects is fitting the rudder feedback unit and ensuring that the geometry matches the full range of rudder movement.

The Type RS Remote Drive gets around this problem with its integrated rudder feedback unit that directly mounts to the drive unit itself. The feedback unit can easily be configured to work with mainstream Autopilot electronics from all major manufacturers.

See available cable lengths and rudder feedback versions on page 11.

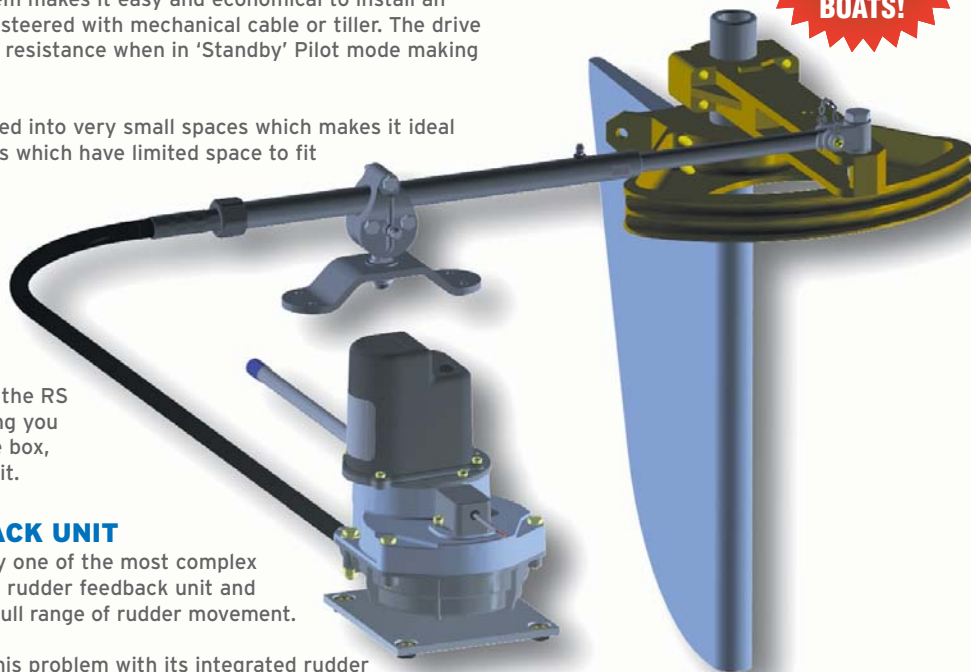

EASY TO BUY

Everything you need supplied in one box - drive unit, 6ft steering cable and linear drive connection kit.

EASY TO FIT

Simple to mount installation kits and the integrated rudder feedback make for easy fitting.

COMPACT

The remote drive unit has a tiny 0.25ft² footprint and can be mounted in the most convenient location on your boat, horizontally or vertically.

RELIABLE & SAFE

Proven, tested design. The drive unit features a manual override without having to disengage the autopilot first.

COMPATIBLE WITH YOUR PILOT

The Type RS Remote Drive System is compatible with all major autopilot brand electronics.

SPECIFICATION

ORDER CODE	MDRS-SYS
MAXIMUM STROKE	305mm / 12in
PEAK THRUST	180kg / 400lbs
MAX RUDDER TORQUE	450nm / 333 lbft
HARD OVER TIME	12-15 seconds
PEAK POWER	7 Amps
AVERAGE POWER	2.5 Amps
TILLER ARM RADIUS	254mm / 10in
MAX DISPLACEMENT (FULLY LADEN)	7000kg / 15,400lbs
MAX BOAT LENGTH	11.5m / 38ft
VOLTAGE	12v DC
CLUTCH CIRCUIT POWER	850mA

SAILBOAT SYSTEMS



HYDRAULIC LINEAR DRIVES

HALF THE CONSUMPTION, TWICE THE RANGE!

PATENTLY BETTER

An important consideration when choosing a Hydraulic Linear Drive for use with a sailboat is the efficiency of the pump unit. An independent comparison by the University of British Columbia between piston pump and gear pump technology was undertaken during the first few years of manufacture of the patented piston design reversing pump from Octopus.

The evaluation showed that a piston pump was three times more efficient than a gear pump. These findings are still true today - an Octopus Linear Drive can be expected to halve the battery consumption when compared to a competitor's unit, therefore doubling the effective range of the autopilot on one battery charge. The graph shows actual test performance of an Octopus Pump compared with an inefficient gear unit.

We have a full range of powerful, low current consumption hydraulic Linear drives that are designed for long passage making. These drives are built for maximum performance. The drives are available in two styles either with the pump mounted on the cylinder or with the pump mounted separately.

See page 10 for the full model list and order codes.

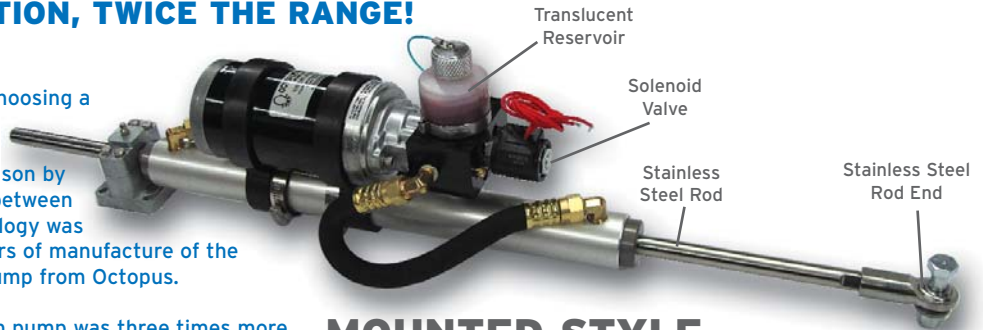

MOUNTED STYLE

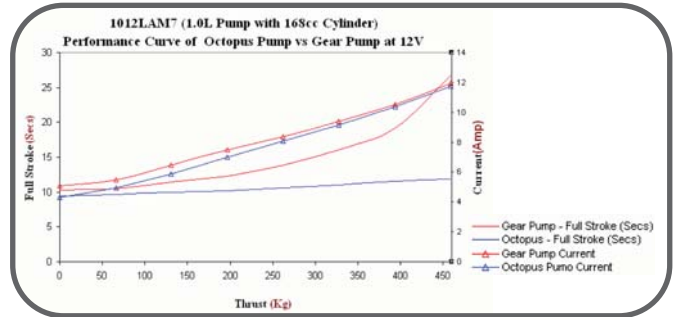

POWERFUL, EFFICIENT HYDRAULIC LINEAR DRIVES FOR YACHTS UP TO 29,000Kg (64,000lbs) MAXIMUM DISPLACEMENT, 100FT (30.5M) PLUS

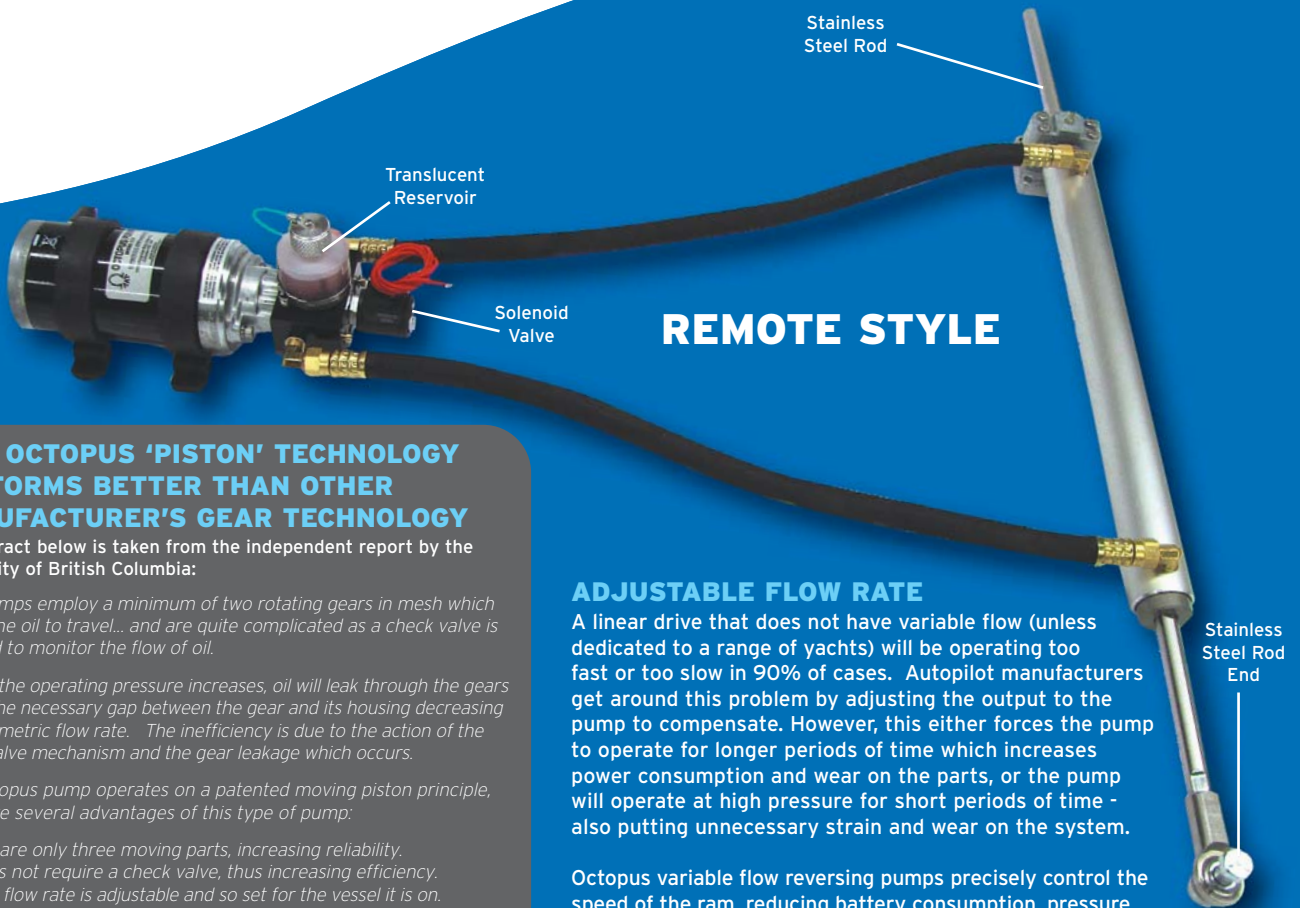

REMOTE STYLE

HOW OCTOPUS 'PISTON' TECHNOLOGY PERFORMS BETTER THAN OTHER MANUFACTURER'S GEAR TECHNOLOGY

The extract below is taken from the independent report by the University of British Columbia:

Gear pumps employ a minimum of two rotating gears in mesh which forces the oil to travel... and are quite complicated as a check valve is required to monitor the flow of oil.

Also, as the operating pressure increases, oil will leak through the gears due to the necessary gap between the gear and its housing decreasing the volumetric flow rate. The inefficiency is due to the action of the check valve mechanism and the gear leakage which occurs.

The Octopus pump operates on a patented moving piston principle, there are several advantages of this type of pump:

1. There are only three moving parts, increasing reliability.
2. It does not require a check valve, thus increasing efficiency.
3. Pump flow rate is adjustable and so set for the vessel it is on.

ADJUSTABLE FLOW RATE

A linear drive that does not have variable flow (unless dedicated to a range of yachts) will be operating too fast or too slow in 90% of cases. Autopilot manufacturers get around this problem by adjusting the output to the pump to compensate. However, this either forces the pump to operate for longer periods of time which increases power consumption and wear on the parts, or the pump will operate at high pressure for short periods of time - also putting unnecessary strain and wear on the system.

Octopus variable flow reversing pumps precisely control the speed of the ram, reducing battery consumption, pressure, strain and wear on the hydraulic system.

SAILBOAT SYSTEMS



HYDRAULIC LINEAR DRIVES (CUSTOM SOLUTIONS)

TWICE THE STEERING FEEL, HALF THE BATTERY CONSUMPTION

SMALL SPACE? THINK BIG!

One of the major obstacles to hydraulic linear drive installation is available space - the fixed configuration of traditional drives meant that often there just wasn't enough room by the rudder, which usually forced the customer to settle for a less powerful alternative.

The LAU Universal Linear Drive sets you free from this limitation - the multiple system design options offers the professional installer the versatility to pick the correct fitting combination to get the job done in a tight space - no more settling for second best!

TWICE THE FEEL ON THE WHEEL

As any helmsperson will tell you, efficiently steering a sailing yacht is dependent on the feedback from the wheel - sailors rely on the feel from the wheel to fine tune the balance of the yacht. The drawback to traditional hydraulic linear drives was the friction from backdriving the steering ram, which often killed this vital feedback. No longer - the unique configuration of the LAU drives means 50% less drag than other drives giving the benefit of more feel on the steering wheel.

LOW POWER CONSUMPTION

High precision technology means battery drain is reduced by up to half!

MAXIMUM PERFORMANCE

Variable flow pumps professionally set the ram speed to ensure the performance is fine tuned to suit the exact steering characteristics of the yacht.

HALF THE DRAG

Offers all the reliability of a hydraulic linear system with 50% less drag (backdrive friction) in manual steering mode giving greater feel on the wheel.

GREATER INSTALLATION FLEXIBILITY

Six different mounting configurations allows the professional to choose the best and simplest installation for each boat.

QUIET OPERATION

The separately mounted pumpset can be positioned in a location which maximises noise suppression.

EASY TO SERVICE

The pumpset includes inbuilt shutoff valves, which are recommended on all professional hydraulic installations - no more bleeding of the system each time the pump is removed for servicing!

STANDARD HOSE LENGTH 6ft (2M)

Custom lengths available.

EASY TO SUPPLY, EASY TO SPECIFY

Available in kit form.

FOUR DRIVE VERSIONS FOR YACHTS UP TO 80FT, 20 TONS

Each with six possible configurations or in universal kit form.

FRONT MOUNTED BP VALVE & RESERVOIR CONFIGURATION OPTIONS



FA OPTION

FB OPTION

FC OPTION

REAR MOUNTED BP VALVE & RESERVOIR CONFIGURATION OPTIONS



RA OPTION

RB OPTION

RC OPTION

SELECTION GUIDE

PART No.	CYLINDER STROKE	PUMP SIZE	VOLTAGE	MAX LENGTH	MAXIMUM DISPLACEMENT
OCTAF1012LAU7	7in	1L	12v	45ft	22,000lbs (10t)
OCTAF1212LAU12	12in	1.2L	12v	60ft	33,000lbs (15t)
OCTAF2012LAU9	9in	2L	12v	70ft	37,500lbs (17t)
OCTAF2012LAU12	12in	2L	12v	80ft	44,000lbs (20t)

Also available in 24v versions.

Choose the best mounting option and include the relevant two letter code at the end of the part no. eg OCTAF1212LAU12FA. See also page 10 for more detailed specifications.

fight the wheel...

...or make life easy

OCTOPUS LAU DRIVES:
"TWICE THE FEEL
ON THE WHEEL"



HYDRAULIC LINEAR DRIVE - APPLICATION GUIDE

HYDRAULIC LINEAR DRIVE SELECTION FOR SAILBOATS

DRIVES	AVERAGE / MAX CURRENT <i>(Piston pump efficiency will reduce actual consumption)</i>	FEATURES				PERFORMANCE			YACHT SELECTION	
		Volts	Cylinder Bore	Variable Flow Rate	Stroke	Hardover Time (Suggested)	Max Rudder Torque	Peak Thrust	Max Boat Length	Max Laden Displacement
1012LAM7 1012LAR7 1012LAU7	4 - 6A / 19A	12V	38MM	500cc - 1 litre/min	178mm 7in	12 - 14 sec	750Nm 6,630lbin	400Kg 882lbs	14m 45ft	11,000Kg 24,200lbs
1024LAM7 1024LAR7 1024LAU7	2 - 3A / 10A	24V	38MM	500cc - 1 litre/min	178mm 7in	12 - 14 sec	750Nm 6,630lbin	400Kg 882lbs	14m 45ft	11,000Kg 24,200lbs
1212LAM12 1212LAR12 1212LAU12	4 - 6A / 19A	12V	38MM	600cc - 1.2 litre/min	305mm 12in	14 - 16 sec	1,200Nm 10,600lbin	400Kg 882lbs	18m 60ft	15,000Kg 33,000lbs
1224LAM12 1224LAR12 1224LAU12	2 - 3A / 10A	24V	38MM	600cc - 1.2 litre/min Reversing	305mm 12in	14 - 16 sec	1,200Nm 10,600lbin	400Kg 882lbs	18m 60ft	15,000Kg 33,000lbs
2012LAR9 2012LAU9	6 - 8 / 22A	12V	45MM	1 - 2 litres/min Reversing	228.6mm 9in	14 - 16 sec	1,200Nm 10,600lbin	600Kg 1,322lbs	22m 70ft	17,000Kg 37,500lbs
2024LAR9 2024LAU9	3 - 4A / 11A	24V	45MM	1 - 2 litres/min Reversing	228.6mm 9in	14 - 16 sec	1,200Nm 10,600lbin	600Kg 1,322lbs	22m 70ft	17,000Kg 37,500lbs
2012LAR12 2012LAU12	6 - 8 / 22A	12V	45MM	1 - 2 litres/min Reversing	305mm 12in	14 - 16 sec	1,500Nm 13,200lbin	600Kg 1,322lbs	24.5m 80ft	20,000Kg 44,000lbs
2024LAR12 2024LAU12	3 - 4A / 11A	24V	45MM	1 - 2 litres/min Reversing	305mm 12in	14 - 16 sec	1,500Nm 13,200lbin	600Kg 1,322lbs	24.5m 80ft	20,000Kg 44,500lbs
CRA0212LAR12	6 - 8 / 22A	12V	45MM	2 litres/min Constant Running	305mm 12in	14 - 16 sec	2,300Nm 20,332lbin	850Kg 1,870lbs	Refer to displacement	29,000Kg 63,800lbs
CRA0224LAR12	3 - 4 / 11A	24V	45MM	2 litres/min Constant Running	305mm 12in	14 - 16 sec	2,300Nm 20,332lbin	850Kg 1,870lbs	Refer to displacement	29,000Kg 63,800lbs

xxxLAMxx = Mounted pump on cylinder version
 xxxLARxx = Remote pump to cylinder version
 xxxLAUxx = Universal drive



LAR: REMOTE PUMP TO CYLINDER VERSION

LAM: MOUNTED PUMP ON CYLINDER VERSION

SAILBOAT SYSTEMS

MECHANICAL DRIVE - ACCESSORIES





ACCESSORY KITS

TYPE S/T DASHBOARD DRIVE ACCESSORY KITS (PAGE 3)

- 

OC15SUK10 90 degree Bezel Mounting Kit - for Type S Straight Shaft Drive
- 

OC15SUK09 20 degree Bezel Mounting Kit - for Type S Straight Shaft Drive
- 

OC15SUK07 Steering Cable Adapter Kit - for TFX SSC72 - Uflex M47 - Morse 304415
- 

OC15SUK08 Steering Cable Adapter Kit - for TFX SSC62 - Uflex M66
- 

OC15SUK11 Adjustable Friction Brake - for Type S Straight Shaft Drive with 90° Bezel Mounting Kit
- 

OC15SUK16 Spacer Kit x 19mm for - 90° Bezel Mounting Kit
- 

OC15SUK17 Spacer Kit x 16mm for - 20° Bezel Mounting Kit
- 

OC15SUK18 Spacer Kit x 13mm - for TFX Performance Tilt Mechanism (Type T)

TYPE R REMOTE DRIVE ACCESSORY KITS (PAGE 4)

- 

OC15SUK12B Type B - Multi I/O Connection Kit - To Fit to Sterndrive Power Assist Steering Cylinders for Mercruiser engines (from 1994) and Volvo Gas engines & Volvo Diesel engines USA (from 1997)
- 

OC15SUK12C Type C - Multi I/O Connection Kit - To fit to Sterndrive Power Assist Steering Cylinders for Mercruiser Saginaw (up to 1993) & Volvo Diesel drives Europe (from 1994)
- 

OC15SUK15A Yamaha 115-220 O/B Installation Kit - for Second Steering Cable Connection to Outboard
- 

OC15SUK15B Mercury-Mariner-Suzuki O/B Installation Kit - for Second Steering Cable Connection to Outboard
- 

OC15SUK19 Universal Connection Kit - for Custom Steering Cable Connection to Tiller or Quadrant
- 

OC15109-6 Standard Steering Cable x 6 foot long
- 

OC15109-9 Standard Steering Cable x 9 foot long
- 

OC15109-12 Standard Steering Cable x 12 foot long

ACCESSORIES FOR TYPE RS SAILBOAT DRIVE (PAGE 7)

- 

OC15211-4 Sail Boat Steering Cable 12 Inch Stroke. 4 foot long
- 

OC15211-6 Sail Boat Steering Cable 12 Inch Stroke. 6 foot long
- 

OC15211-9 Sail Boat Steering Cable 12 Inch Stroke. 9 foot long
- 

OC15SUK26 Universal Connection Kit 12 inch Stroke

RUDDER FEEDBACK UNITS

FOR TYPE S/T DASHBOARD DRIVE, R & RS REMOTE DRIVES (PAGES 3,4&7)

- 

OC15SUK27 Rudder Feed Back Module - Universal Kit for all versions of Autopilots
- 

OC15SUK27A Rudder Feed Back Module - For Sitex Autopilots

HYDRAULIC DRIVE - ACCESSORIES

MODULAR ACCESSORY KITS FOR REVERSING PUMPS

VALVE ACCESSORIES



OC17SUK01 #8 Bypass Valve Manifold 12v DC
 OC17SUK02 #8 Bypass Valve Manifold 24v DC

OC17SUK03 Unbalanced Valve



CONSTANT FLOW REGULATOR VALVE

OC17SUK19 Constant Flow Regulator Valve

This regulator valve runs with an engine driven pump, and is usually fitted to commercial boats that require a constant hydraulic flow for use with a steering cylinder for an autopilot. Please refer to our website or contact us for the possible different versions available.



HYDRAULIC HOSE KIT

OC17SUK34 Verado Hose Kit

SI-TEX MARINE ELECTRONICS

