

SIMRAD

B&G

NAC-2/NAC-3

Commissioning Manual

ENGLISH



Preface

Disclaimer

As Navico is continuously improving this product, we retain the right to make changes to the product at any time which may not be reflected in this version of the manual. Please contact your nearest distributor if you require any further assistance.

It is the owner's sole responsibility to install and use the equipment in a manner that will not cause accidents, personal injury or property damage. The user of this product is solely responsible for observing safe boating practices.

NAVICO HOLDING AS AND ITS SUBSIDIARIES, BRANCHES AND AFFILIATES DISCLAIM ALL LIABILITY FOR ANY USE OF THIS PRODUCT IN A WAY THAT MAY CAUSE ACCIDENTS, DAMAGE OR THAT MAY VIOLATE THE LAW.

Governing Language: This statement, any instruction manuals, user guides and other information relating to the product (Documentation) may be translated to, or has been translated from, another language (Translation). In the event of any conflict between any Translation of the Documentation, the English language version of the Documentation will be the official version of the Documentation.

This manual represents the product as at the time of printing. Navico Holding AS and its subsidiaries, branches and affiliates reserve the right to make changes to specifications without notice.

Trademarks

NMEA® and NMEA 2000® are registered trademarks of the National Marine Electronics Association.

Copyright

Copyright © 2016 Navico Holding AS.

Warranty

The warranty card is supplied as a separate document.

Compliance statements

This equipment complies with:

- CE under EMC directive 2014/30/EU
- The requirements of level 2 devices of Radiocommunications (Electromagnetic Compatibility) standard

About this manual

The manual assumes that the user has basic knowledge of navigation, nautical terminology and practices.

Important text that requires special attention from the reader is emphasized as follows:

→ **Note:** Used to draw the reader's attention to a comment or some important information.

⚠ **Warning:** Used when it is necessary to warn personnel that they should proceed carefully to prevent risk of injury and/or damage to equipment/personnel.

Manual version

This manual is written for software version 1.0. The manual is continually updated to match new software releases.

Contents

7	Introduction
7	NAC-2 and NAC-3 autopilot computers
7	Autopilot controllers
7	Autopilot computer setup
10	Dockside setup
10	Data source selection
10	Boat characteristics
10	Drive configuration
13	Rudder setup
16	Sea trial
16	Compass setup
17	Transition speed
18	Set rudder zero position
18	Set turn rate
18	Tuning the autopilot
23	User settings
23	Steering profile settings
24	Sailing parameters
25	Turn pattern settings
29	Installation verification
29	Checklist
29	Boat specific settings
32	Maintenance
32	Preventive maintenance
32	Checking the connectors
32	Software update
32	Resetting the autopilot computer
34	Technical specifications
34	NAC-2
35	NAC-3

37 Dimensional drawings

37 NAC-2

37 NAC-3

38 Supported data

38 NMEA 2000 PGNs

41 NMEA 0183 sentences

42 NMEA 2000 PGN description

1

Introduction

NAC-2 and NAC-3 autopilot computers

The NAC-2 and NAC-3 autopilot computers contain the electronics needed to operate a hydraulic steering pump or mechanical drive unit, while also interfacing with rudder feedback units and NMEA 2000 devices.

The NAC-2 is designed for boats up to 10 metres (33 feet) in length and is suitable for low-current pumps, mechanical drive units, or solenoid valves (8 amps continuous/16 amps peak).

The NAC-3 is designed for boats 10 metres (33 feet) or greater in length and is rated to operate high-current pumps, mechanical drive units, and solenoid valves (30 amps continuous/50 amps peak).

Autopilot controllers

The NAC-2 and NAC-3 autopilot computers can be controlled by various Simrad and B&G control units. This can be dedicated autopilot controllers (e.g. AP44), Multifunction displays (MFDs) and autopilot remote controllers (e.g. OP12) used in combination with instrument systems, or any combination of the above.

Autopilot functions

NAC-2 and NAC-3 include a large range of functions, but not all autopilot controllers have access to all options. E.g. autopilot systems including only an autopilot remote controller (without display unit) do not have access to turn patterns.

The user interface

The autopilot functions are presented slightly different on the different displays.

This manual shows screen examples from both MFDs and AP44.

Autopilot computer setup

When the autopilot installation is completed, the setup of the autopilot computer must be performed. Failure in setting up the autopilot correctly may prohibit the autopilot from functioning properly.

The setup of the autopilot computer is divided in three main steps:

- Installation settings
 - Including dockside and seatrial commissioning. See "*Dockside setup*" on page 10 and "*Sea trial*" on page 16
- User adjustment of autopilot settings
 - Manual fine-tuning for various operational conditions and user preferences. See "*User settings*" on page 23

→ **Note:** The Installation settings can only be accessed when the autopilot is in Standby mode. Some systems require a dedicated physical standby key to perform installation procedures. This key can be a key on the autopilot controller, on an autopilot remote controller, or it can be a separate standby key.

⚠ Warning: When the autopilot is delivered from factory and any time after an autopilot reset has been performed, the installation settings are all reset to factory preset (default) values. A notification will be displayed, and a complete setup has to be made. Failure to do so correctly may prohibit the autopilot from functioning properly!

Installation setup workflow

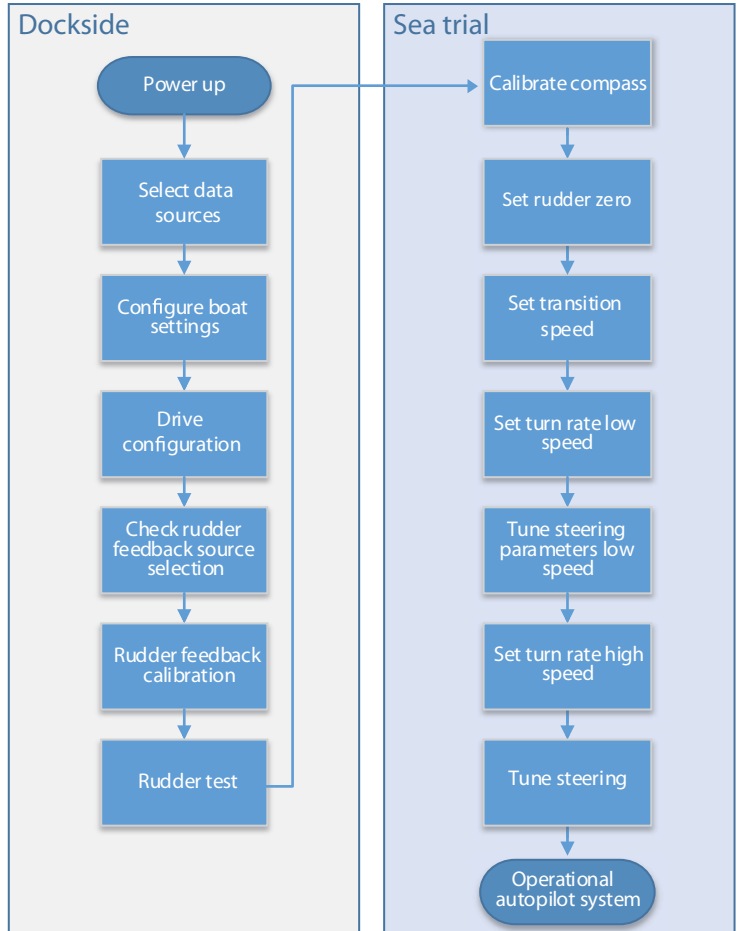

2

Dockside setup

Data source selection

Before commencing with autopilot computer setup the data sources must be available and configured.

Data sources selection is required on initial start-up of the system, if any part of the network has been changed or replaced, or if an alternative source is made available for a given data type and this source has not been selected automatically.

You can let the system automatically select your sources, or set up each source manually. Refer to documentation for the autopilot controller or for the display unit for details about how to perform the data source selection.

Boat characteristics

Boat type

Affects steering parameters as well as available autopilot features.

The following options are available:

- Sail
- Displacement
- Planing

→ **Note:** If the boat type is set to Sail, Virtual Rudder Feedback is not available.

Boat length

Used by the autopilot system to calculate steering parameters.

Cruising speed

Used if no speed info is available. It is used by the autopilot system to calculate steering parameters.

Drive configuration

The drive configuration controls how the autopilot computer operates the steering system.

Refer to your drive unit documentation for relevant specifications.

Control method

Used for setting the appropriate control output for your drive.

The following options are available:

- Solenoid
For on/off steering of hydraulic valves. Gives fixed rudder speed.
- Reversible motor
For variable speed pumps/drives.

Drive voltage

Nominal drive voltage specified for your drive unit.

- Options: 12 V and 24 V.

→ **Note:** 24 V output is only available with 24 V supply.

The setting must match the spec of the solenoids/pump/motor.

⚠ Warning: Selection of improper voltage level for your drive unit may damage both the drive unit and the autopilot computer even if the protection circuits are activated.

Drive engage

Defines how the Engage output is used.

The following options are available:

- Clutch
If your drive unit/motor/pump needs clutch to engage the actuator, it shall be connected to the "engage" output. Configure the "Drive engage" as clutch. The clutch will be activated when autopilot computer is controlling the rudder. In standby, the clutch is released to allow manual steering. Check specification of your drive unit to determine whether clutch is required.
- Auto
Output activated when autopilot computer is in Auto, NoDrift or Navigation modes. For manual rudder control (Standby, NFU and FU) the output is not activated. Typically used to switch between two rudder speeds on a continuous running pump, used when

different rudder speeds are required for automatic and Follow-up/Non-Follow-up steering.

Minimum rudder

Some boats may have a tendency to not respond to small rudder commands around the “course keeping” position because of a small rudder, whirls/disturbance of the water-stream passing the rudder, or it is a single nozzle water jet boat. By increasing the Minimum rudder parameter you may improve the course keeping performance on some boats. However, this will increase the rudder activity.

→ **Note:** Only set a value for minimum rudder if it proves to give a better course keeping performance in calm sea. It should be set after the autopilot steering parameters have been optimised/tuned.

Rudder deadband

Prevents the rudder from hunting induced by mechanical play in the steering gear or rudder.

The following options are available

- Auto
(Recommended).
The rudder deadband is adaptive and is continuously operative. It will also optimize the deadband to the pressure on the rudder
- Manual
If the Auto setting doesn't perform properly due to extreme rudder speed and/or overshoot, it can be adjusted manually. Can also be used to reduce the rudder activity. Rudder commands smaller than the size of the dead band will be ignored

Find the lowest possible value that will prevent the rudder from continuous hunting. A wide deadband will cause inaccurate steering. It is recommended to check rudder stability in AUTO mode at cruising speed to get pressure on the rudder. (Slight hunting observed dockside may disappear at cruising speed.)

Rudder setup

⚠ Warning: During the rudder calibration and test the autopilot computer issues a series of rudder commands. Stand clear of the helm and do not attempt to take manual control of the rudder during this test!

Rudder source

The correct rudder source has to be selected before the rudder feedback calibration can be performed.

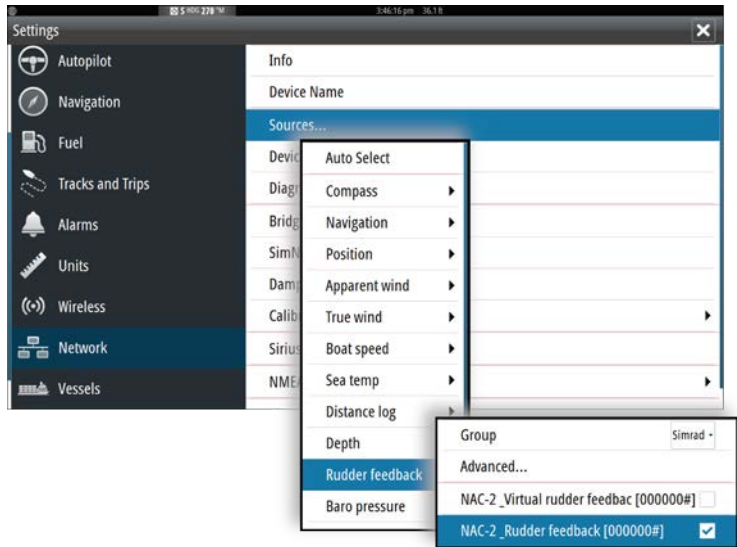

Rudder source selection, MFDs

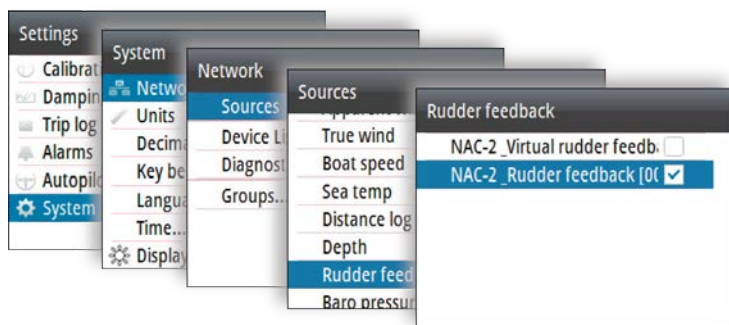

Rudder source selection, AP44

→ **Note:** Virtual Rudder Feedback (VRF) should only be used if no rudder feedback is available. Installing a feedback unit will enhance the performance of an autopilot and provide an accurate rudder angle indicator on the autopilot display.

→ **Note:** VRF is not available if boat type is set to Sail.

Rudder feedback calibration

→ **Note:** Only available if you have a rudder feedback unit installed and selected as rudder source.

The rudder feedback calibration determines the rudder feedback's direction.

- Follow the on-screen guided steps until the rudder calibration is completed.

Rudder test

This rudder test verifies the drive direction. It detects minimum power to drive the rudder and reduces the rudder speed if it exceeds the maximum preferred speed for autopilot operation.

→ **Note:** If the boat uses power assisted steering, it is important that the engine or electric motor used to enable the power assist steering is turned on prior to this test.

- Run the rudder test as described in the on-screen instructions
 - Rudder should make a small movement within 10 seconds, then follow up with travelling both directions

Failure to complete test will result in an alarm.

VRF calibration

→ **Note:** Only available if the rudder source is set to a virtual rudder feedback.

VRF calibration determines the direction of rudder movement, the minimum output required to move the rudder and the voltage to rudder speed ratio.

To perform the VRF calibration you must be able to view the movement of the rudder.

- Follow the on-screen guided steps until the VRF calibration is completed.

3

Sea trial

A sea trial can only be performed after the dockside settings are completed.

→ **Note:** The sea trial must always be performed in calm conditions, in open waters and at a safe distance from other traffic!

Compass setup

To achieve the best possible performance, the compass should be calibrated, and any offsets should be compensated for.

The setup needs to be done from an appropriate display unit. Depending on the unit, access to the compass setup is available from the compass's device dialog, or from a dedicated Calibration option in the unit's Settings menu.



Device dialog, MFDs

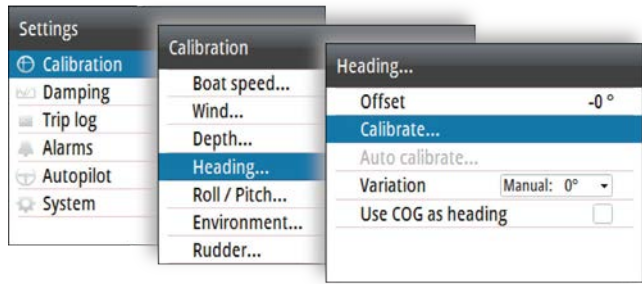

Calibration option, AP44

→ **Note:** The setup of the compass should be done in calm sea conditions and with minimal wind and current to obtain good results. Ensure that there is enough open water around the vessel to make a full turn.

Refer to your heading sensor's documentation for further details for your unit.

Transition speed

The transition speed is the speed at which the system automatically changes between **Low** speed and **High** speed steering profiles.

The steering profiles are used to accommodate the boats' tendency to exhibit different steering characteristics at different speeds. You may also have different preferences about the steering performance of your boat required at low and high speeds.

On power boats it is recommended that you set a value that represents the speed where the boat's steering characteristics change. For instance the planing threshold (recommended), or at the speed you want the autopilot to change behavior.

There is a 2 knots hysteresis to prevent oscillation of high/low settings when the vessel is travelling at or near the transition speed.

Example

The transition speed is set to 9 knots.

- The system changes from Low profile to High profile when the speed increases to 10 knots (= Transition speed plus 1 knot)
- The system changes from High profile to Low profile when the speed decreases to 8 knots (= Transition speed minus 1 knot)

The active profile ('Low' or 'High') is shown in the autopilot page (e.g. AP44) and in the autopilot pop-up (MFDs):



AP44 page



MFD Autopilot pop-up

Set rudder zero position

Used to correct the rudder zero position found during dockside commissioning if the boat needs a small rudder offset in order to steer straight.

- **Note:** Setting rudder zero position should always be done in calm conditions, where steering is not affected by wind and/or current.
- Bring the rudder to the position where the boat steers straight, then activate the **Set rudder zero** option to save the rudder zero parameter.
- **Note:** On dual engine boats, verify that the engine RPM is equal on both engines so that the thrust from both propellers is equal. Otherwise, the zero rudder position might be set wrong.

Set turn rate

Used for setting the preferred turn rate of the boat.

- Bring the boat into a turn with the preferred safe and comfortable turn rate, then activate the **Set turn rate** option to save the turn rate parameters.
- **Note:** The captured turn rate will be stored in the active steering profile. This setting must therefore be repeated for each steering profile.

Tuning the autopilot

- **Note:** Tuning of the autopilot must be done separately for low and high speed profiles.

Both Autotune and manual tuning should be performed in calm or moderate sea conditions.

Providing you have entered correct vessel type, length and cruising speed, you may not have to perform further manual or automatic tuning.

Proceed as follows to verify satisfactorily steering:

1. Stabilize the vessel on a heading, and then select **AUTO** mode
2. Observe course keeping and rudder commands
 - The autopilot should keep the vessel on the set heading within an average of +/-1 degree, providing calm sea and wind
3. Make some small and bigger heading changes to port and starboard and observe how the vessel settles on the new heading
 - The vessel should have a minimum of overshoot. See "*Rudder gain*" on page 21 and "*Counter rudder*" on page 21.

If the autopilot is not keeping the heading satisfactorily or not making the turns satisfactorily, you may now either try the Autotune function or go directly to manual tuning.

- **Note:** If the vessel is more than approximately 30 m/100 ft or has a very high cruising speed it may be unpractical to perform Autotune. It is then suggested to proceed with manual tuning.

Autotuning

When performing an autotune, the vessel will automatically be taken through a number of S-turns. Based on the vessel behavior, the autopilot will automatically set the most important steering parameters (Rudder gain and Counter rudder).

- Stabilize the vessel on a heading and set the speed as close to cruising speed as possible, then activate the **Autotune** function.
 - The autopilot will now switch to AUTO mode and take control of the vessel.

- **Note:** Autotuning can be stopped at any time by pressing the **STBY** key on the autopilot controller.

The autotuning takes approximately 3 minutes to complete. When completed the autopilot automatically switches to Standby mode, and the rudder must be controlled manually.

- **Note:** All parameters that are set during autotuning can be manually adjusted. For optimal steering performance it is recommended to manually adjust the steering parameters after running the autotune.

Manual tuning

Rudder gain and Counter rudder can be manually adjusted.

- Stabilize the vessel on a heading and set the speed in the middle of the profile range (well clear of the transition speed) to avoid profile switching during tuning. Then activate the **Rudder gain** option. Adjust the value according to the descriptions below.
- If required, adjust slightly the **Counter rudder** option.

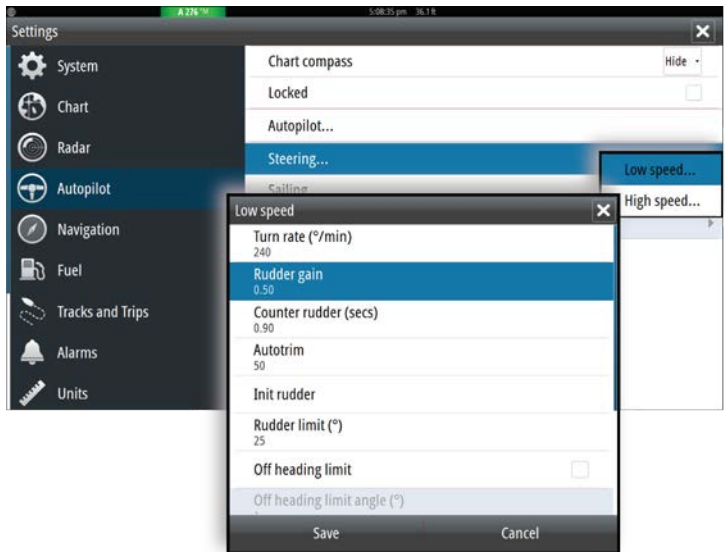

Tuning parameters, MFDs

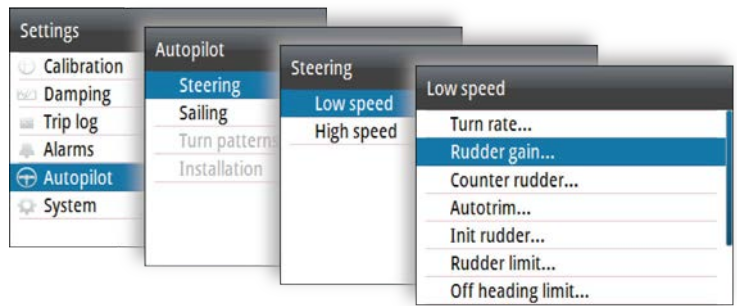

Tuning parameters, AP44

Rudder gain

This parameter determines the ratio between commanded rudder and the heading error. The higher rudder gain value the more rudder is applied. If the value is too small it will take a long time to compensate for a heading error, and the autopilot will fail to keep a steady course. If the value is set too high the overshoot will increase and the steering will be unstable.

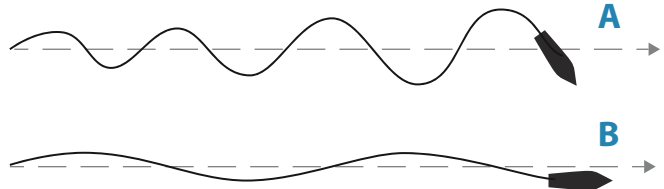

- A** The value is set too high. Steering becomes unstable and often the overshoot will increase
- B** The value is set too low. It will take a long time to compensate for a heading error, and the autopilot will fail to keep a steady course

Counter rudder

Counter rudder is the amount of counteracting (opposite) rudder applied to stop the turn at the end of a major course change. The settings depend on vessel's characteristics, inertia, hull shape and rudder efficiency.

- If the vessel has good dynamic stability, a relatively small value will be sufficient
- An unstable vessel will require high value
- The greater the vessel's inertia, the greater value will be required

Increasing counter rudder value may result in some higher rudder activity also when steering a straight course, particularly in high waves.

The best way of checking the value of the Counter rudder setting is when making turns. The figures illustrate the effects of various Counter Rudder settings.

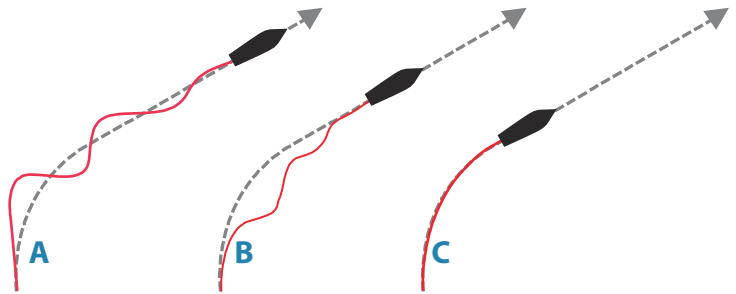

- A** Counter rudder value too low; overshoot response
- B** Counter rudder value is too high; sluggish and creeping response
- C** Correct setting of Counter rudder; ideal response

Perform various course changes and observe how the boat settles on the new heading. Start with small changes, 10-20 degrees, and proceed with bigger changes, 60-90 degrees. Adjust Counter rudder value to obtain best possible response as in illustration **C**.

→ **Note:** As many boats turn differently to port versus starboard (due to propeller rotation direction), do the course changes in both directions. You may end up with a compromise setting of Counter rudder that gives a little overshoot to one side and a bit creeping response to the other.

4

User settings

The user settings can be configured differently between the different profiles, depending on boat steering characteristics and user preferences.

Steering profile settings

The NAC-2 and NAC-3 include two steering profiles (High and Low), used for high and low boat speed.

The initial parameters are automatically assigned when you select your vessel type. During the seatrial the parameters will be tuned for optimized steering performance. See "*Tuning the autopilot*" on page 18.

The options listed in the next pages are available for both High and Low speed profiles.

For Rudder gain and Counter rudder, see "*Rudder gain*" on page 21 and "*Counter rudder*" on page 21.

Turn rate

Used for manually setting the turn rate defined during seatrials (Set turn rate option).

Autotrim

Controls how fast the autopilot will apply rudder to compensate for a constant heading offset, e.g. when external forces such as wind or current affects the heading. Lower autotrim will give faster elimination of a constant heading offset

→ **Note:** In VRF mode this parameter controls the time constant of the rudder estimate. A lower value makes the rudder estimate faster, i.e. that it will more quickly catch up with the boat's movements.

Init rudder

Defines how the system moves the rudder when switching from power steering to an automatic mode.

The following options are available:

- Center
Moves the rudder to zero position

- Actual
Maintains the rudder angle, and assumes that the current rudder angle is the trim required to maintain a steady heading.

Rudder limit

Determines the dynamic range of the rudder before its movement is restricted and alarm is triggered. Typical usage is to limit the amount of rudder action caused by yawing in following sea.

→ **Note:** Rudder limit is not a hard limitation of the rudder range, only around the current setpoint.

This Rudder limit does not affect Non-Follow-up or Follow Up steering.

Off heading limit angle

Sets the limit for the off heading alarm.

When the alarm option is activated an alarm occurs when the actual heading deviates from the set heading more than the selected limit.

Track response

Defines how aggressively the autopilot should steer towards the active route's leg.

Track approach angle

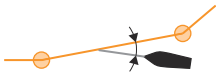

This setting is a limit to prevent approaching the track too steeply. Approaching the track at shallower angles is permitted depending on the cross track distance (XTD) and track response setting.

This setting is used both when you start navigating and whenever the autopilot is working the boat towards the route.

Course change confirm angle

Defines the limit for automatic course change to next waypoint in a route when the autopilot is following a route (NAV mode).

If the course change is greater than this set limit, you are prompted to verify that the upcoming course change is acceptable.

Sailing parameters

→ **Note:** Only available if the boat type is set to SAIL.

Wind mode

Select what wind angle the autopilot will steer towards.

The following options are available:

- Auto
If True Wind Angle (TWA) is $<70^\circ$: Wind mode will steer towards Apparent Wind Angle (AWA)
If TWA is $\geq 70^\circ$: Wind mode will steer towards TWA
- Apparent
Steers towards AWA
- True
Steers towards TWA

Tack time

Controls how fast the autopilot tacks in wind mode.

Tack angle

Controls the angle that the boat will tack to in AUTO mode.

Manual speed

If neither boat speed nor SOG data are available and/or deemed unreliable, a manual value for speed can be entered and used by the autopilot to aid steering calculations.

Turn pattern settings

The autopilot computer supports a number of automatic turn steering features when the autopilot is in AUTO mode.

→ **Note:** Turn pattern steering is not available if the boat type is set to Sail.

All turn patterns, except the U-turn, have associated turn pattern settings. Depending on the autopilot controller these turn pattern settings can be adjusted before you start the turn or during the turn.

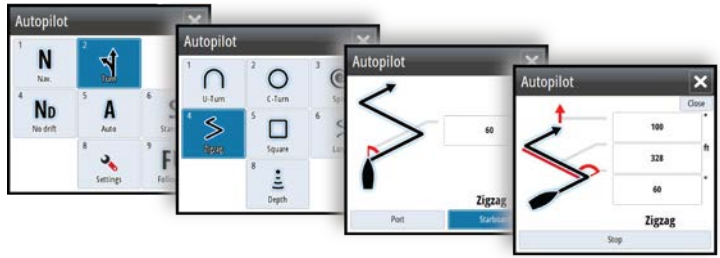

Turn pattern settings, MFD

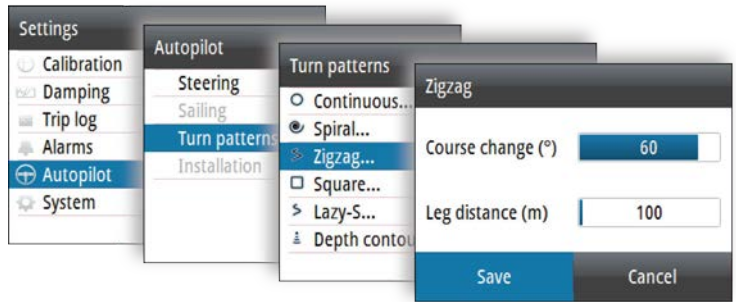

Turn pattern settings, AP44

→ **Note:** Not all autopilot controllers include turn pattern steering. Refer to your autopilot controller for more information.

C-turn (Continuous turn)

Steers the vessel in a circle.

- Turn variable:
 - Rate of turn. Increasing the value makes the vessel turn a smaller circle.

U-turn

Changes the current set heading to be 180° in the opposite direction.

Spiral turn

Makes the vessel turn in a spiral with a decreasing or increasing radius.

- Turn variables:
 - Initial radius
 - Change/turn. If this value is set to zero, the boat will turn in a circle. Negative values indicate decreasing radius while positive values indicate increasing radius.

Zigzag turn

Steers the vessel in a zigzag pattern.

- Turn variables:
 - Course change (**A**)
 - Leg distance (**B**)

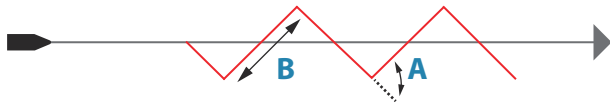

Square turn

Makes the vessel automatically turn 90° after having travelled a defined leg distance.

- Turn variable:
 - Leg distance

Lazy-S turn

Makes the vessel yaw around the main heading.

- Turn variables:
 - Course change (**C**)
 - Turn radius (**D**)

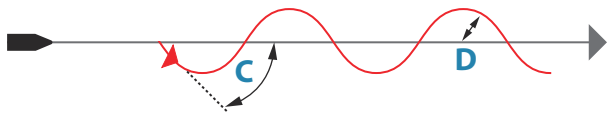

Depth contour tracking (DCT)

Makes the autopilot follow a depth contour.

- **Note:** DCT turn pattern is only available if the system has a valid depth input.
- Turn variables:
 - Depth gain. This parameter determines the ratio between commanded rudder and the deviation from the selected depth contour. The higher depth gain value the more rudder is applied. If the value is too small it will take a long time to compensate for drifting off the set depth contour, and the autopilot will fail to keep the boat on the selected depth. If the value is set too high the overshoot will increase and the steering will be unstable.
 - CCA. The CCA is an angle that is added to or subtracted from the set course. With this parameter you can make the boat yaw around the reference depth with lazy-s movements. The larger the CCA the bigger yawing will be allowed. If the CCA is set to zero there is no S-ing.
 - Ref. depth. This is the reference depth for the DCT function. When DCT is initiated the autopilot reads the current depth and set this as the reference depth. The reference depth can be changed when the function is running.
- **Note:** If depth data is lost during DCT the autopilot will automatically switch to AUTO mode.
It is recommended to turn ON the AP Depth Data Missing alarm when using DCT. When this alarm is activated an alarm will be raised if the depth data is lost during DCT.

5

Installation verification

When all units in the autopilot system are installed, external equipment connected and the software configured according to the previous chapters, the installation should be verified according to the checklist. The boat specific settings should be noted down in the relevant tables included this chapter.

Checklist

Description	Reference
Units mounted and secured according to instructions	Installation instructions for the units
Network powered and terminated according to instructions	Wiring instructions for the units
Sources selected	Autopilot control unit documentation
Vessel configured	" <i>Boat characteristics</i> " on page 10
Drive units configured and calibrated	" <i>Drive configuration</i> " on page 10
Compass calibrated	" <i>Compass setup</i> " on page 16
Sea trial completed (manual or autotune)	" <i>Sea trial</i> " on page 16

Boat specific settings

Boat

Settings	
Boat type	
Boat length	
Cruising speed	
Transition speed	

Drives

Settings	
Drive type	
Drive control method	
Nominal drive voltage	
Drive engage	
Minimum rudder	
Rudder deadband	
Manual deadband	
Minimum output	
Maximum output	

Sailing parameters

Settings	
Wind mode	
Tack time	
Tack angle	
Manual speed	

Steering profiles

Settings	Low Speed	High Speed
Turn Rate		
Rudder gain		
Counter rudder		
Autotrim		
Init rudder		
Rudder limit		

Settings	Low Speed	High Speed
Off heading limit		
Track response		
Track approach angle		
Course change confirm angle		

Turn Pattern settings

Settings	
Continuous	
Rate of turn	
Spiral	
Initial radius	
Change/turn	
Zigzag	
Course change	
Leg distance	
Square	
Leg distance	
Lazy-S	
Course change	
Turn radius	
Depth contour	
Depth gain	
CCA	

6

Maintenance

Preventive maintenance

The unit does not contain any field serviceable components. Therefore, the operator is required to perform only a very limited amount of preventative maintenance.

Checking the connectors

The connectors should be checked by visual inspection only. Push the connector plugs into the connector. If the connector plugs are equipped with a lock, ensure that it is in the correct position.

Software update

You can update the software for the autopilot computer from a display unit connected to the network.

You can check the autopilot computer's software version from the display unit's Device list.

Resetting the autopilot computer

You can reset the autopilot to factory default settings.

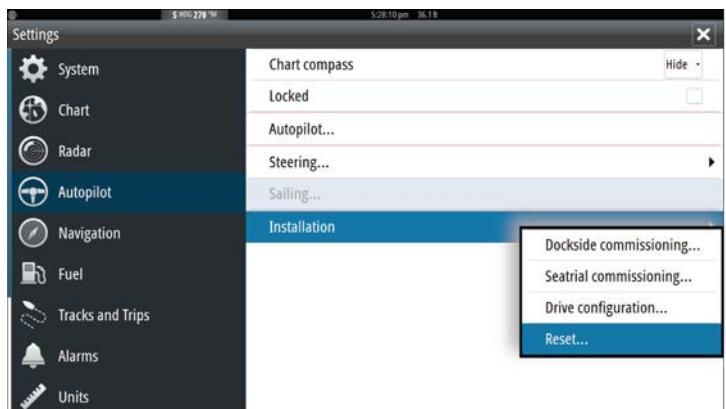

Reset autopilot computer, MFDs

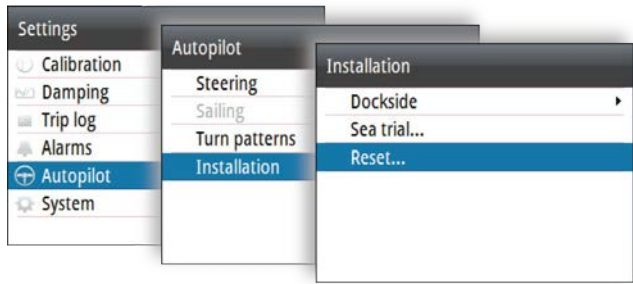

Reset autopilot computer, AP44

The first time the autopilot computer is started after reset, it will run through the automatic setup-procedure.

- **Note:** Unless you need to clear all values set during the installation set-up procedure, you should not perform a reset of the autopilot computer.

7

Technical specifications

NAC-2

Approvals	
Compliance	EMC directive 2014/30/EU
Electrical	
Supply voltage	9-31.2 V DC
Power consumption - Max	500 W
Power consumption - Typical	As required to drive rudder actuator. See pump/motor power ratings
Recommended fuse rating	20 A
Environmental	
Operating temperature	-25°C to +55°C (-13°F to 131°F)
Storage temperature	-30°C to +70°C (-22°F to 158°F)
Waterproof rating	IPx5
Humidity	100%
Shock and vibration	Acc to EN60945
Connectivity	
NMEA 2000	1 Micro-C port, 1 LEN
Drive	12/24 V DC, min 10 mA, max 3 A
Rudder Feedback	Variable voltage/resistive 0-5 V
NMEA 2000 PGNs	See " <i>NMEA 2000 PGNs</i> " on page 38
Physical	
Dimensions	See " <i>NAC-2</i> " on page 37
Weight	0.6 kg (1.3 lbs)
Compass Safe Distance	500 mm (20 inches)
Warranty	2 years

NAC-3

Approvals	
Compliance	EMC directive 2014/30/EU
Electrical	
Supply voltage	12/24 V DC +/- 10-30%
Power consumption - Max	750 W
Power consumption - Typical	As required to drive rudder actuator. See pump/motor power ratings
Recommended fuse rating	30 A
Environmental	
Operating temperature	-25°C - +55°C (-13°F - 131°F)
Storage temperature	-30° - +70°C (-22°F - 158°F)
Waterproof rating	IPx5
Humidity	100%
Shock and vibration	Acc to EN60945
Connectivity	
NMEA 2000	1 Micro-C port, 1 LEN
NMEA 0183	1 port IN/OUT. 4.8, 9.6, 19.2 & 38.4 kbaud
Drive	<ul style="list-style-type: none"> Reversible motor control of rudder. Max continuous load 30 A, peak 50 A for 1s or <ul style="list-style-type: none"> On/off solenoid control of rudder. 12/24 V DC, common, load range 10 mA to 10 A, off current <1 mA
Engage	Output for bypass/clutch. 12/24 V DC, min 10 mA, max 3 A

Rudder	Rudder angle, frequency input. 15 V, 1.4 to 5 kHz, resol. 20 Hz/°
Remote	<ul style="list-style-type: none"> • Input: External open/close contact for remote controller • Output: High/Low mode indicator signal
Mode	External open/close or pulse contact for autopilot disengage
Alarm	External alarm output for buzzer/relay. Max 100 mA, voltage level as local supply
Physical	
Dimensions	See "NAC-3" on page 37
Weight	0.7 kg (1.6 lbs)
Compass Safe Distance	500 mm (20 inches)
Warranty	2 years

8

Dimensional drawings

NAC-2

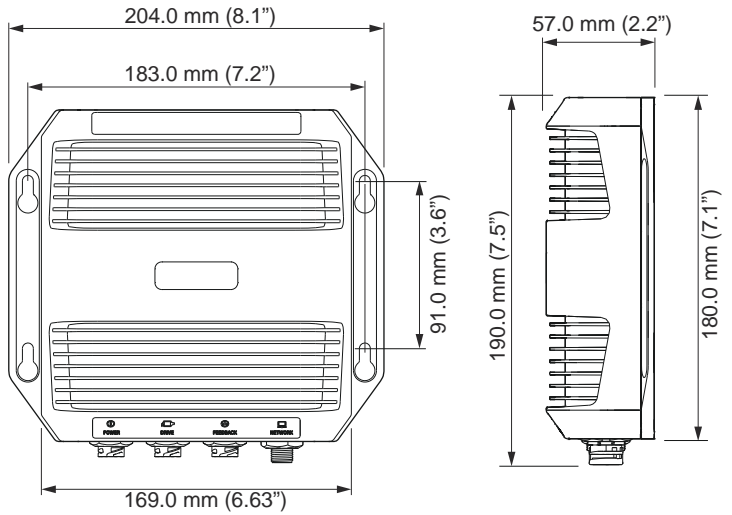

NAC-3

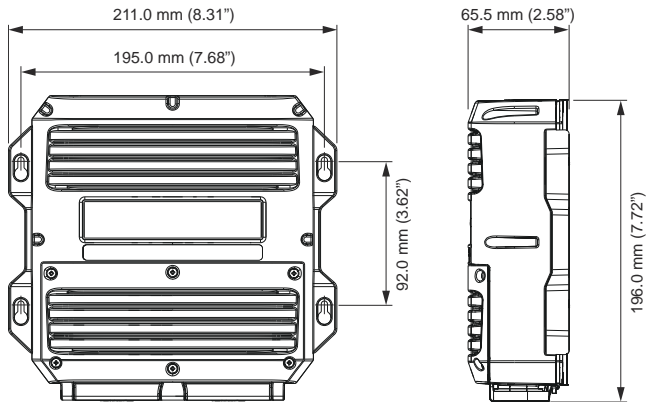

9

Supported data

NMEA 2000 PGNs

NAC-2

- MD: Main Device
- RF: Rudder Feedback
- VRF: Virtual Rudder Feedback

	MD		RF		VRF	
	TX	RX	TX	RX	TX	RX
59392	x	x	x	x	x	x
59904	x	x	x	x	x	x
60160	x	x	x	x	x	x
60416	x	x	x	x	x	x
60928	x	x	x	x	x	x
65240		x		x		x
65305	x	x				
65323	x	x				
65341	x					
65342	x	x				
126208	x	x	x	x	x	x
126996	x	x	x		x	
127237	x	x				
127245	x	x	x		x	
127250		x				
127251		x				
127257		x				
127258		x				
128259		x				
128267		x				
129025		x				

	MD		RF		VRF	
	TX	RX	TX	RX	TX	RX
129026		x				
129029		x				
129283		x				
129284		x				
130306		x				
130577		x				
130821	x					
130840	x	x				
130845	x	x	x		x	
130846	x	x	x		x	
130850	x	x	x		x	
130851	x	x	x		x	
130856	x	x				
130860	x					

NAC-3

- MD: Main Device
- RF: Rudder Feedback
- VRF: Virtual Rudder Feedback
- NM: NMEA 0183
- CD: Control Device

	MD		RF		VRF		NM		CD	
	TX	RX	TX	RX	TX	RX	TX	RX	TX	RX
59392	x	x	x	x	x	x	x	x	x	x
59904	x	x	x	x	x	x	x	x	x	x
60160	x	x	x	x	x	x	x	x	x	x
60416	x	x	x	x	x	x	x	x	x	x
60928	x	x	x	x	x	x	x	x	x	x
65240		x		x		x		x		x
65305	x	x							x	
65323	x	x								
65341	x									
65342	x	x								
126208	x	x	x	x	x	x	x	x	x	x
126996	x	x	x		x		x		x	
127237	x	x					x			
127245	x	x	x		x		x		x	
127250		x					x			
127251		x					x			
127257		x					x			
127258		x					x			
128259		x					x			
128267		x					x			
129025		x					x			
129026		x					x			
129029		x					x			

	MD		RF		VRF		NM		CD	
	TX	RX	TX	RX	TX	RX	TX	RX	TX	RX
129283		x					x			
129284		x					x			
130306		x					x			
130577		x								
130821	x									
130840	x	x								
130845	x	x	x		x		x		x	
130846	x	x	x		x		x		x	
130850	x	x	x		x				x	
130851	x	x	x		x				x	
130856	x	x								
130860	x									

NMEA 0183 sentences

	In	Out	NMEA 2000 PGN
AAM	x		129284
ACK	x		130850
APB	x		129283 129284 129285
BOD	x		129284
BWC	x		129284
DPT	x		128267
GGA	x		129025 129029
GLL	x		129025 129029
HDG	x	10*	127250

	In	Out	NMEA 2000 PGN
HDT	x	10**	127250
HSC	x		127237
RMA	x		129025 129026 127258
RMB	x		129283 129284
RMC	x		127258 129025 129026 129033
ROT	x		127251
RSA		5	127245
THS	x		127250
VBW	x		128259
VHW	x		127250 128259
VLW	x		129026
VTG	x		129026
ZDA	x		129033

* When magnetic heading source.

** When true heading source.

NMEA 2000 PGN description

59392	ISO Acknowledgement
59904	ISO Request
60160	ISO Transport protocol, Data transfer
60416	ISO Transport protocol, Connection management, RTS group function
60928	ISO Address claim
65240	ISO Commanded address

126208	ISO Command group function
126996	Product information
127237	Heading/Track control
127245	Rudder
127250	Vessel heading
127251	Rate of turn
127257	Attitude
127258	Magnetic variation
128259	Speed, Water referenced
128267	Water depth
129025	Position, Rapid update
129026	COG & SOG, Rapid update
129029	GNSS Position data
129283	Cross Track Error
129284	Navigation data
129283	Cross Track Error
129284	Navigation data
130306	Wind data
130577	Direction data

Index

A

- About
 - NAC-2 and NAC-3 7
 - User interface 7
- Autopilot
 - Autotuning 19
 - Controllers 7
 - Functions 7
 - Manual tuning 20
 - Reset 32
 - Setup 7
 - Tuning 18

B

- Boat
 - Cruising speed 10
 - Length 10
 - Transition speed 17
 - turn rate 18
 - Type 10

C

- Characteristics
 - Boat 10
- Checklist
 - Boat characteristic settings 29
 - Boat specific settings 29
 - Description
 - Reference 29
 - Drive Settings 30
 - Installation verification 29
 - Sailing parameters 30
 - Steering profile settings 30
 - Turn pattern settings 31
- Commissioning
 - Sea Trial 16
- Compliance

Compatibility standard 4

D

- Data source selection 10
- Drawings
 - NAC-2 Dimensions 37
 - NAC-3 dimensions 37
- Drive
 - Configuration 10
 - Engage, Clutch, Auto 11
 - Settings, Solenoid, Reversible motor 11
 - Voltage 11

F

Factory default settings 32

I

Installation setup workflow 9

M

- Manual
 - About 4
 - Software, Version, download 4

N

- NMEA 0183 sentences 41
- NMEA 2000 PGNs 38, 40
- NMEA 2000
 - PGN description 42

R

- Rudder
 - Counter values 21
 - deadband, Auto, Manual 12

- feedback, calibration 14
- Gain, ratio 21
- Init, center, actual 23
- Limit 24
- minimum, activity 12
- setup 13
- source, VRF 13
- Test 14
- VRF, calibration 15
- Zero position 18

S

Settings

- Autotrim 23
- Off heading limit angle 24
- Sea trial 16
- Steering profiles 23
- Track response 24
- Turn Rate 23
- User 23

Setting

- Course change confirm angle, NAV mode 24
- Manual speed 25
- Sailing parameters 24
- Tack angle 25
- Tack time 25
- Track approach angle 24
- Turn patterns 25
- Wind mode
 - Auto
 - Apparent
 - True 25

Setup

- Compass, Device dialog,
- Calibration option 16
- Dockside 10

Supported data

- NMEA 0183 sentences 41

- NMEA 2000 PGNs -
- NAC-3 40
- NMEA 2000 PGNs,
- NAC-2 38

T

Technical Specifications

- NAC-2
 - Warranty 34, 35
- NAC-3

Turn Patterns

- C-turn 26
- Depth countour tracking, depth gain, CCA 27
- Lazy-S turn 27
- Spiral turn 27
- Square turn 27
- U-turn 26
- Zigzag turn 27

U

Unit

- Checking the connectors 32
- Preventive maintenance 32

Update

- Software, NAC-2 and NAC-3 32