

SIMRAD

S5100 Sonar module

Installation manual

ENGLISH



Preface

Disclaimer

As Navico is continuously improving this product, we retain the right to make changes to the product at any time which may not be reflected in this version of the manual. Please contact your nearest distributor if you require any further assistance.

It is the owner's sole responsibility to install and use the equipment in a manner that will not cause accidents, personal injury or property damage. The user of this product is solely responsible for observing maritime safety practices.

NAVICO HOLDING AS AND ITS SUBSIDIARIES, BRANCHES AND AFFILIATES DISCLAIM ALL LIABILITY FOR ANY USE OF THIS PRODUCT IN A WAY THAT MAY CAUSE ACCIDENTS, DAMAGE OR THAT MAY VIOLATE THE LAW.

This manual represents the product as at the time of printing. Navico Holding AS and its subsidiaries, branches and affiliates reserve the right to make changes to specifications without notice.

Governing Language

This statement, any instruction manuals, user guides and other information relating to the product (Documentation) may be translated to, or has been translated from, another language (Translation). In the event of any conflict between any Translation of the Documentation, the English language version of the Documentation will be the official version of the Documentation.

Copyright

Copyright © 2016 Navico Holding AS.

Warranty

The warranty card is supplied as a separate document.

Compliance statements

This equipment complies with:

- CE under EMC directive 2014/30/EU
- The requirements of level 2 devices of the Radio communications (Electromagnetic Compatibility) standard 2008

About this manual

Intended audience

This manual is a reference guide for installing the S5100. The manual is written for marine electronics technicians, and assumes some prior knowledge and skills relevant to the type of work to be carried out.

Important text conventions

Important text that requires special attention from the reader is emphasized as follows:

→ **Note:** Used to draw the reader's attention to a comment or some important information.

⚠ Warning: Used when it is necessary to warn personnel that they should proceed carefully to prevent risk of injury and/or damage to equipment/ personnel.

Trademarks

Navico® is a registered trademark of Navico.

Simrad® is used by license from Kongsberg.

NMEA® and NMEA 2000® are registered trademarks of the National Marine Electronics Association.

Contents

6	Introduction
6	Overview
6	Parts included
7	Connectors and LED location
8	Installation
8	Mounting location
8	Transducer installation
9	Wiring
9	Guidelines
9	Grounding the unit
10	Power connection
11	Connecting the S5100 to MFD systems
12	Transducer connection
14	Troubleshooting
14	LED indicators
15	Maintenance
15	Preventive maintenance
15	Checking the connectors
15	Software update
16	Spare parts and accessories
16	S5100 Spare parts and accessories
16	Transducers
17	Technical specifications
17	S5100
18	Dimensional drawings
18	S5100

1

Introduction

Overview

The S5100 is a networked triple CHIRP module including 3 independent sonar channels. This allows for simultaneous use of High, Medium and Low CHIRP, and for dual independent ranges on a single screen. In addition, each frequency range can be viewed on connected MFDs in the network.

The module is compatible with a variety of Navico's Multi-Function Displays (MFDs).

Parts included

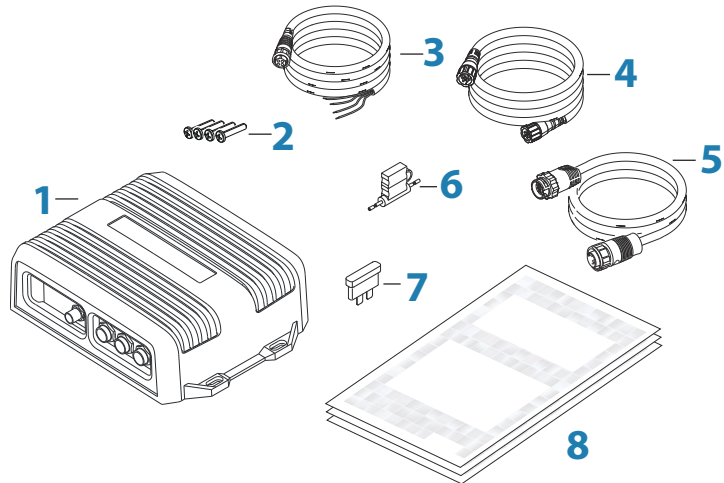

- 1 S5100 unit
- 2 (4x) Fixing screws, Phillips stainless steel, 25 mm (1")
- 3 Power cable, 2 m (6.5 ft)
- 4 Ethernet cable, 1.8 m (6 ft)
- 5 (3x) 7 to 9 pin adapter cables, 0.6 m (2 ft)
- 6 Fuse holder
- 7 Fuse, 5 Amp
- 8 Documentation pack

Connectors and LED location

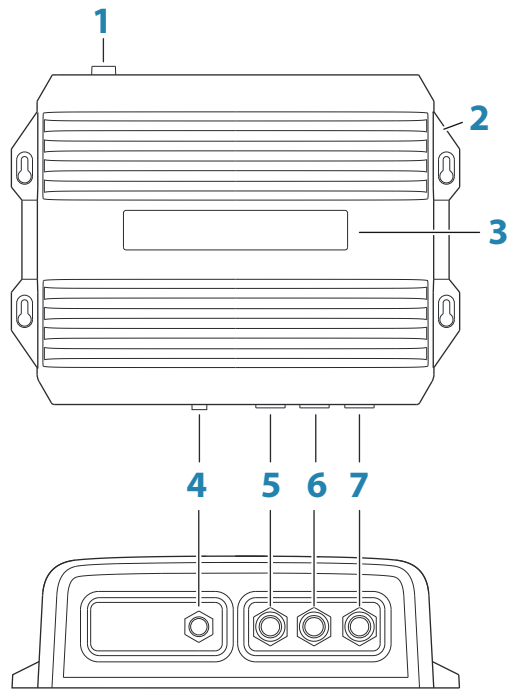

- 1** Power connector
- 2** Grounding screw
- 3** LED status indicators
- 4** Ethernet connector
- 5** Sonar channel 1
- 6** Sonar channel 2
- 7** Sonar channel 3

2

Installation

Mounting location

Choose the mounting locations carefully before you drill or cut.

For overall width and height requirements, refer to "*Dimensional drawings*" on page 18.

Do not mount any part where it can be used as a hand hold, where it might be submerged, or where it will interfere with the operation, launching, or retrieving of the boat.

The unit should be mounted so that the operator can easily see the LED status indicators.

Check that it is possible to route cables to the intended mounting location.

Leave sufficient clearance to connect all relevant cables.

The unit can be mounted on a horizontal or on a vertical surface. Create drip loops when the unit is mounted on a vertical surface with connections exiting upwards.

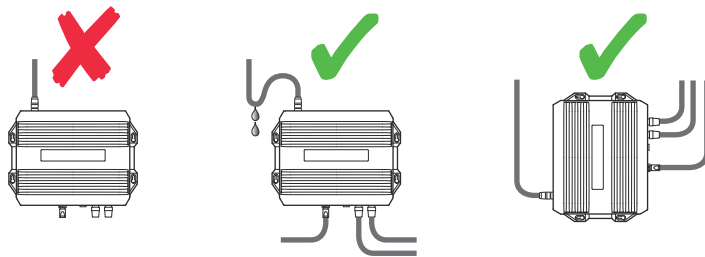

Before cutting a hole in a panel, make sure that there are no hidden electrical wires or other parts behind the panel.

Ensure that any holes cut are in a safe position and will not weaken the boat's structure. If in doubt, consult a qualified boat builder, or marine electronics installer.

→ **Note:** Where flush mounted, the enclosure should be dry and well ventilated. In small enclosures, it may be required to fit forced cooling.

⚠ Warning: Inadequate ventilation and subsequent overheating of the unit may cause unreliable operation and reduced service life. Exposing the unit to conditions that exceeds the specifications could invalidate your warranty. – refer to "*Technical specifications*" on page 17.

Transducer installation

For transducer installation information, refer to separate installation instructions included with the transducer.

3

Wiring

Guidelines

Don't:

- make sharp bends in the cables
- run cables in a way that allows water to flow down into the connectors
- run the data cables adjacent to radar, transmitter, or large/high current carrying cables or high frequency signal cables.
- run cables so they interfere with mechanical systems

Do this:

- make drip and service loops
- use cable-tie on all cables to keep them secure
- solder/crimp and insulate all wiring connections if extending or shortening the cables. Extending cables should be done with suitable crimp connectors or solder and heat shrink. Keep joins as high as possible to minimize possibility of water immersion.
- leave room adjacent to connectors to ease plugging and unplugging of cables

⚠ Warning: Before starting the installation, be sure to turn electrical power off. If power is left on or turned on during the installation, fire, electrical shock, or other serious injury may occur. Be sure that the voltage of the power supply is compatible with the unit.

⚠ Warning: The positive supply wire (red) should always be connected to (+) DC with the supplied fuse or a circuit breaker (closest available to fuse rating).

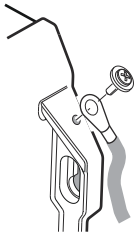

Grounding the unit

For additional safety, install grounding cable in ground screw hole as indicated on the illustration. Recommended 16 awg wire.

Power connection

The unit is designed to be powered by a 12 or 24 V DC system. It is protected against reverse polarity, under voltage and over voltage (for a limited duration).

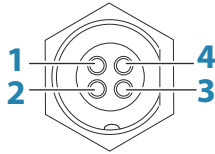

Unit socket (male)

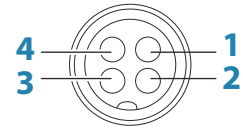

Cable plug (female)

Key	Purpose	Color
1	DC negative	Black
2	Not used	Blue
3	Power control	Yellow
4	+12/24 V DC	Red

Power control

The unit has no power key and will turn on when power is applied.

If the unit is connected directly to the vessel's battery, the module will continue to draw power even when it is not in operation. It is recommended that the yellow power cable wire be fitted with an optional on/off switch, allowing the unit to be powered off when not in use.

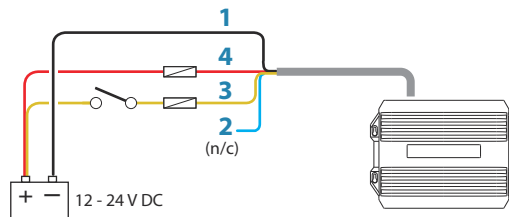

Some MFD systems can be configured for power control. When the S5100 is used in such systems it is recommended to connect the unit to the power control bus and set the MFD to power control master. Refer to your MFD documentation for more information.

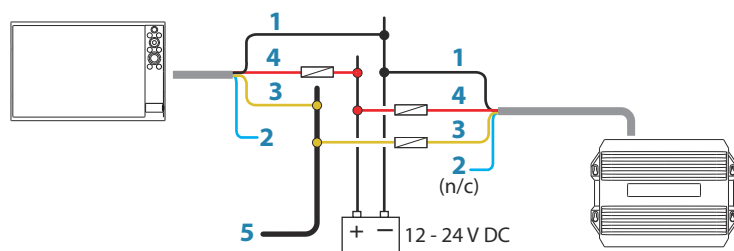

Key	Purpose	Color
1	DC negative	Black
2	Not connected	Blue
3	Power control	Yellow
4	+12/24 V DC	Red
5	Power control bus	

Connecting the S5100 to MFD systems

The S5100 connects to your MFD system over the Ethernet network.



Key	Purpose	Color
1	Transmit positive TX+	Blue/White
2	Transmit negative TX-	Blue
3	Receive positive RX+	Orange/White
4	Receive negative RX-	Orange
5	Shield	Bare

The illustration shows:

- how the S5100 connects to a single MFD (A), and how MFDs with two Ethernet connectors can daisy chain (B) to share sonar data
- how sonar data from the S5100 can be shared by connecting the MFDs via a network expansion port (C)

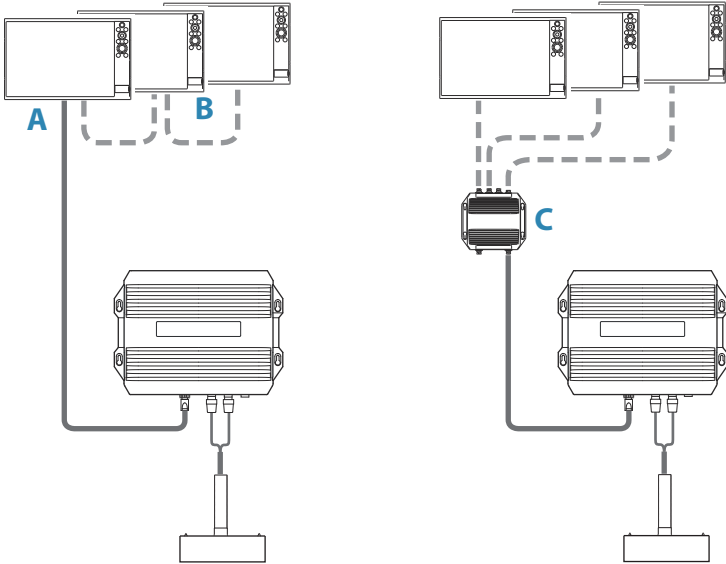

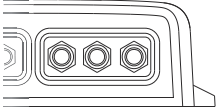

Transducer connection

⚠ Warning: Removing the transducer cables from the S5100 while the module is powered on can cause sparks that can damage the S5100 transmitter as well as the transducers. Remove the transducer cables only after the module has been disconnected from its power source.

Transducers with 9 pin connector

Up to three 9 pin transducers can be connected directly to any of the sonar channels on the S5100.

One 9 pin transducer can be connected to the remaining open channel after a dual connector transducer has been attached.

Transducers with 7 pin connector

Transducers with a blue 7 pin connector must be connected to S5100 by using the 7-9 adapter cable. 3 of these adapter cables are included in the box.

The adapter cable connects to any of the sonar channels.

Transducers with bare wires

Transducers with bare wires must be connected to the S5100 via the optional Junction box (A) (part number 000-13262-001).

The Junction box cable connects to the sonar channels as follows:

- single frequency transducers: to any of the sonar channels
- dual frequency transducers: to Channel-1 and Channel-2, or to Channel-2 and Channel-3 as described in "*Transducers with two connectors*" on page 13

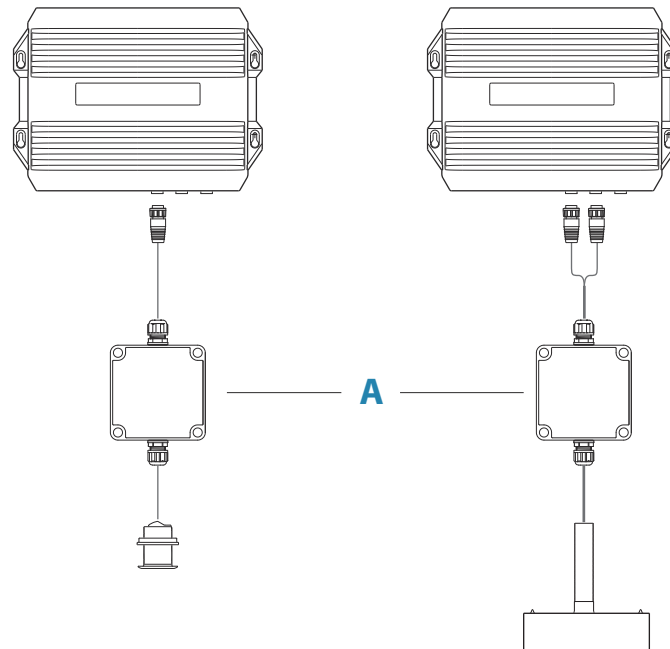

Detailed installation description and wiring diagram is included with the junction box.

Transducers with two connectors

When using transducers with two connectors:

- connect the high frequency element connector (**A**) to the Channel-1 or Channel-2 plug
- connect the low frequency element connector (**B**) to the plug to the immediate right of the plug used for the high frequency connector.

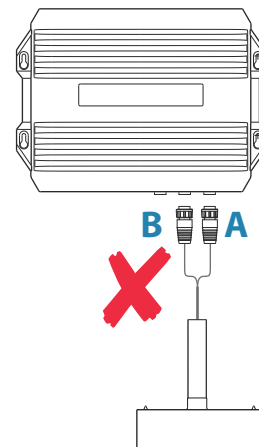
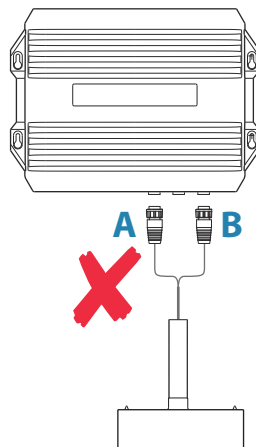
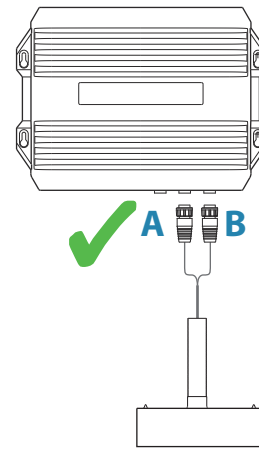
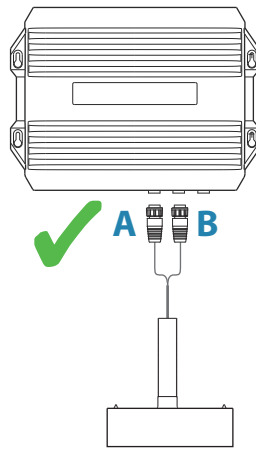

4

Troubleshooting

LED indicators

5 LEDs on the unit's cover indicate status for the S5100, for the network and for connected transducers.

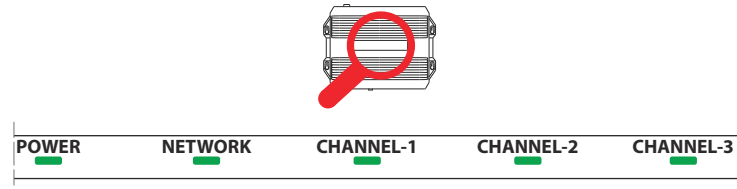

Power LED

- OFF
 - No power connection
 - Check power and power cable
 - Check yellow wire
- ON - Red
 - System starting
- ON - Green
 - System operational
- FLASHING - Red/Green
 - Software error or unit reprogrammed
 - Restart the unit

Network LED

- OFF
 - No Ethernet connection
 - Check cable
- ON - Green
 - Ethernet connected and ok

Sonar LEDs

- OFF
 - Transducer not connected
- FLASHING every 0.5 second - Red
 - Initializing transmitter
- FLASHING every second - Green
 - Searching for bottom signal
- ON - Green
 - System operational

5

Maintenance

Preventive maintenance

The unit does not contain any field serviceable components. Therefore, the operator is required to perform only a very limited amount of preventative maintenance.

Checking the connectors

The connectors should be checked by visual inspection only.

Push the connector plugs into the connector. If the connector plugs are equipped with a lock, ensure that it is in the correct position.

Software update

You can update the software for the S5100 from a display unit connected to the network. Software version can be viewed on the Echosounder page when the S5100 is selected as the sonar source.



Software version can also be viewed from the Sonar Installation dialog when one of the S5100 channels is selected as the source.



The latest software is available for download from the product website.

1. Download the latest software and save it to a memory card
2. Insert the memory card to the display unit
3. Start the File explorer, and select the update file on the memory card
4. Start the update from the file details dialog
5. Remove the memory card when the update is completed

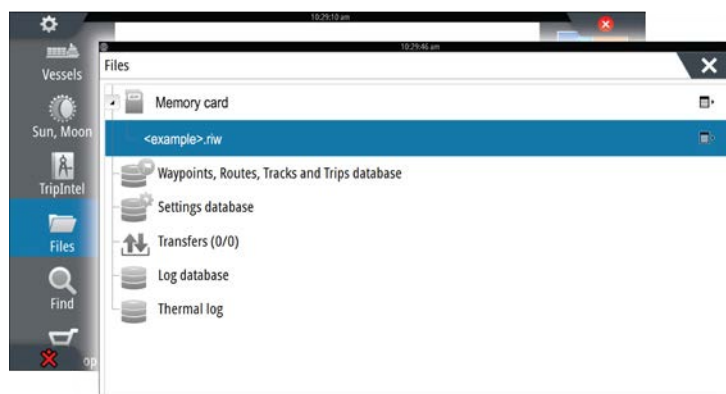

The dialog image examples are from a Simrad MFD.

6

Spare parts and accessories

S5100 Spare parts and accessories

Item	Part number
Power cable, length 1.8 m (6 ft)	000-00128-001
Ethernet cable yellow 5 Pin, 2 m (6.5 ft)	000-0127-51
Ethernet cable yellow 5 Pin, 4.5 m (15 ft)	000-0127-29
Ethernet cable yellow 5 Pin, 7.7 m (25 ft)	000-0127-30
Ethernet cable yellow 5 Pin, 15.2 m (50 ft)	000-0127-37
Junction box with adapter cable for bare wire transducers	000-13262-001
7 to 9 pin adapter cable for 7 pin Airmar transducers	000-13313-001

7

Technical specifications

S5100

Approvals	
Compliance	EMC directive 2014/30/EU
Standard	IEC 60945
Connectivity	
Transducer	3 x 9-pin sonar connectors
Ethernet	1 x 100 Mbps
Power	1 x 4-pins power connector
Electrical	
Supply voltage - Operating	9-32 V DC
Supply voltage - OFF to ON	10.4 - 31.2 V DC
Power consumption - Max	85 W
Recommended fuse rating	5 Amp
Environmental	
Operating temperature range	-15°C - +55°C (5°F - 131°F)
Storage temperature	-30°C - +70°C (-22°F - 158°F)
Waterproof rating	IPx5
Humidity	Up to 95% at 35°C (95°F) non-condensing
Shock and vibration	Acc to IEC 60945
Physical	
Dimensions	See " <i>Dimensional drawings</i> " on page 18
Weight	4.7 kg (10.4 lbs)
Compass Safe Distance	1.8 m (6 ft)
Sonar specification	
Power output	600 W - 3 kW RMS (dependent on transducer)
Frequencies	25 - 250 kHz
Transmitter and receiver type	3 tuned CHIRP transmitters 3 Broadband tuned receivers
Warranty Period	2 years

8

Dimensional drawings

S5100

