

**Uniden®**

**Atlantis 155**



**Marine VHF Radio**

**OWNER'S MANUAL**

# MAKING A DISTRESS CALL

For future reference, write your boat's name & call sign here:

## Speak slowly - clearly - calmly.

1. Make sure your radio is on.
2. Press the **16/9 TRI** button to switch to Channel 16 (156.8 MHz). (If the display does not show 16, press the **16/9 TRI** button again until it does.)
3. Press the **Push to Talk** button and say: "**MAYDAY -- MAYDAY -- MAYDAY.**"
4. Say "**THIS IS** {name of your boat (three times) and call sign/ boat registration number (once)}."
5. Repeat "**MAYDAY** {name of your boat}" once.
6. Tell where you are: (what navigational aids or landmarks are near, or read the latitude and longitude from your GPS).
7. State the nature of your distress (e.g. sinking, medical emergency, man overboard, on fire, adrift, etc.).
8. State the type of assistance you need (medical, towing, pumps, etc.).
9. Give the number of persons aboard and describe the condition of any injured persons.
10. Estimate present seaworthiness of your ship (e.g. how immediate is the danger due to flooding or fire).
11. Briefly describe your ship, giving ship name (i.e., "Blue Duck is 32 foot cabin cruiser, white hull, blue deck house").
12. Say: "**I WILL BE LISTENING ON CHANNEL 16.**"
13. End the message by saying "**THIS IS** {name or call sign of your boat}, **OVER.**"
14. Release the **Push to Talk** button and listen.

**If you do not get an answer after 30 seconds, repeat your call beginning at step 3 above.**

# TABLE OF CONTENTS

<b>ATLANTIS 155 INTRODUCTION</b> .....	<b>7</b>
<b>FEATURES</b> .....	<b>7</b>
<b>GETTING STARTED</b> .....	<b>8</b>
<b>WHAT'S INCLUDED</b> .....	<b>8</b>
<b>CONTROLS AND INDICATORS</b> .....	<b>9</b>
<b>KEY OPERATION</b> .....	<b>10</b>
<b>ATLANTIS 155 LCD DISPLAY</b> .....	<b>11</b>
<b>CONNECTING POWER</b> .....	<b>12</b>
<b>RECHARGING THE ATLANTIS 155</b> .....	<b>13</b>
Battery Level Display .....	<b>14</b>
<b>ATTACHING THE BELTCLIP</b> .....	<b>14</b>
To attach the belt clip:.....	<b>14</b>
To remove the belt clip: .....	<b>14</b>
<b>OPERATION</b> .....	<b>14</b>
<b>BASICS</b> .....	<b>15</b>
Power On/Off .....	<b>15</b>
Volume .....	<b>15</b>
Select a Channel .....	<b>15</b>
Set Squelch .....	<b>15</b>
<b>TRANSMITTING AND RECEIVING</b> .....	<b>16</b>
Selecting Channel Modes .....	<b>16</b>
Transmitting .....	<b>17</b>
Receiving.....	<b>17</b>
<b>HOW IT WORKS</b> .....	<b>18</b>
<b>NORMAL MODE OPERATION</b> .....	<b>18</b>
Normal mode with Weather Alert Watch .....	<b>19</b>
Normal mode with Triple Watch .....	<b>19</b>
<b>SCAN MODE OPERATION</b> .....	<b>20</b>
Using the radio in scan mode .....	<b>20</b>
Scan mode with Weather Alert Watch .....	<b>20</b>
Scan mode with Triple Watch.....	<b>21</b>

<b>WEATHER MODE</b> .....	<b>21</b>
Using the radio in weather mode .....	21
Weather mode with Weather Alert Watch.....	22
Weather mode with Triple Watch .....	22
Emergency Channel 16/9 .....	22
Triple Watch .....	23
<b>DROP-OUT DELAY</b> .....	<b>23</b>
<b>BATTERY SAVE</b> .....	<b>23</b>
<b>BACKLIGHTING</b> .....	<b>23</b>
<b>ADJUST LCD CONTRAST</b> .....	<b>24</b>
<b>KEYPAD LOCK</b> .....	<b>24</b>
<b>KEY BEEP</b> .....	<b>24</b>
<b>SPEAKER VIBRATION TONE</b> .....	<b>24</b>
<b>MAINTENANCE &amp; TROUBLESHOOTING</b> .....	<b>25</b>
COMMON QUESTIONS.....	25
<b>SPECIFICATIONS</b> .....	<b>26</b>
<b>CHANNELS AND FREQUENCIES (MHZ)</b> .....	<b>28</b>
MARINE RADIO CHANNEL CHART.....	28
<b>REGULATIONS AND SAFETY WARNINGS</b> .....	<b>33</b>
MARITIME RADIO SERVICES OPERATION.....	33

# ATLANTIS 155 INTRODUCTION

The Atlantis 155 is a floating, waterproof, portable 3 Watt two-way VHF marine transceiver. It is compact, lightweight, rugged, and fits easily in your hand. This handheld VHF marine radio will give you consistent, outstanding performance in virtually all conditions and situations.

To ensure that you get the most from the Atlantis 155 features, please read this operating guide carefully before using the unit.

## FEATURES

- US, Canadian, and International Marine Channels
- Built-in Precision Matched Antenna
- Floating / Waterproof to JIS7
- Key Beep
- Emergency CH16/ CH9 Mode
- 10 Weather Channel/Weather Alert
- Battery Level Display
- Battery Low Alert sounds every 5 seconds at Level 1
- Boost capability
- Battery Save
- Memory Scan
- Triple Watch
- TX Power Select
- Channel Select
- Volume Select
- 4-Level Digital Squelch
- Keypad Lock On / Off
- Background color changes - 2 colors and 4 levels (Uniden recommends Day - White; Night - Amber).
- User-selectable LCD Contrast (32 levels from 0 to 31)
- Speaker Vibration Tone
- DC Adapter
- Detachable wrist strap

\*Protected against the effects of continuous immersion in water. The Atlantis 155 can withstand immersion in water up to 3.5 feet depth for 30 minutes. The Atlantis 275 has a special tone that will vibrate the speaker to remove water inside the casing (see page E-18).

 **Note: This is not suitable for scuba diving.**



The Atlantis 155 will float when the battery cover is securely fastened.

## GETTING STARTED

### WHAT'S INCLUDED



Atlantis 155 Radio



DC Adapter

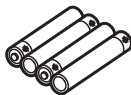

4 AAA Rechargeable  
Ni-MH Batteries



Belt Clip

Not Shown:  
Wrist Strap  
Owner's Manual



If any of these items are missing or damaged, contact Uniden Customer Service (see back cover for contact information).

## CONTROLS AND INDICATORS



No.	Description	No.	Description
1	Antenna	11	<b>SQL UIC</b> (Squelch)
2	<b>PTT</b> (Push-To-Talk)	12	<b>VOL ▼</b>
3	Power Boost	13	<b>WX ALERT</b>
4	<b>CH ▲</b>	14	<b>VOL ▲</b>
5	<b>CH ▼</b>	15	<b>16/9 TRI</b>
6	<b>H/L LOCK</b>	16	LCD Screen
7	Speaker	17	DC IN/Headset Jacks
8	Drainage Opening	18	Wrist Strap
9	SCAN MEM	19	
10	Microphone		

## KEY OPERATION

Key	Press to...	Press and hold to...
<b>Push-to-Talk</b>	NA	Transmit on a channel
<b>BOOST</b>	NA	Boost transmission power to 3W.
<b>Channel Up/ Channel Down</b>	Move up or down one channel at a time.	Move quickly up or down the channels.
<b>H/L Lock</b>	Change the transmit power from Low (1W) to High (3W).	Lock the keys; press again to unlock.
<b>SCAN MEM</b>	Start scanning the channels saved in memory.	Save a channel into memory or delete a channel from memory.
<b>SQL UIC</b>	Enter Squelch Setting mode. Press <b>SQL UIC</b> to select squelch settings (Levels = 0 - 3).	Switch between US, Canadian, or International channels.
<b>VOL ▼</b>	Lower the volume (Levels = 0 - 15).	Quickly lower the volume.
<b>WX ALERT</b>	Listen to the weather channels.	Turn Weather Alert Watch on and off.
<b>VOL ▲</b>	Raise the volume (Levels = 0 - 15).	Quickly raise the volume.
<b>16/9 TRI</b>	1st press: Go to channel 16. 2nd press: Go to channel 9. 3rd press: Go back to the starting channel.	Turn Triple Watch on and off.
	Select LCD backlight level (high, middle, or low) then color (white or amber).	Turn the radio on and off.

## ATLANTIS 155 LCD DISPLAY

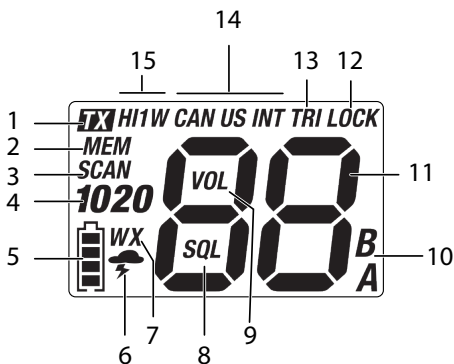

No.	Name	Description
1	TX (or RX)	TX = Transmitting RX = Receiving
2	MEM	Memory. Displays when the current channel is saved to memory.
3	SCAN	Displays when scanning.
4	10 20	Indicates if channel numbers have leading 10 or 20 (1078, 2078).
5	Battery Status	Indicates battery level remaining.
6	WX ALERT	Displays when Weather Alert Watch enabled.
7	WX Mode	Displays when in Weather mode.
8	SQL	Squelch
9	VOL	Volume

No.	Name	Description
10	B, A	B, A = Canadian Channels (21B, 22A, etc)
11	CH Number	Current channel number
12	LOCK	Indicates Key Lock function is on.
13	TRI	Indicates whether Triple Watch is enabled.
14	Country Mode	Indicates which country mode the channel is in (CANada, US, or INTernational).
15	HI 1W	Indicates transmitting power level (Low = 1W; HIGH = 3W)

## CONNECTING POWER

The radio connects to power through a single DC adapter.

1. Connect the DC adapter to the DC 12V jack on the side of the radio.
2. Plug the other end of the adapter into the cigarette lighter.

## INSTALL THE BATTERIES

Your radio uses the supplied 4 rechargeable AAA NiMH batteries. To install the batteries:

1. Make sure the radio is off.
2. Remove the belt clip if necessary.
3. Use a screwdriver or the screwdriver tip on the belt clip to turn the battery compartment screw counterclockwise and then lift up and remove the battery cover.



4. Insert the batteries into the battery compartment.
5. Before placing the battery cover back on the radio, check the rubber seal around the battery compartment. Make sure that the seal is in good condition and that there is no foreign matter under the seal.  
If the rubber seal appears worn, nicked, or dried out, replace it.
6. Replace the battery compartment door. Tighten the screw securely.

## RECHARGING THE ATLANTIS 155

Your radio includes a DC adapter for charging. Follow these instructions to recharge the radio.



**NOTE**

For the initial battery charge, make sure the radio is off for optimum charging.

1. Insert the adapter into the cigarette lighter. Refer to page 12.
2. Connect the other end of the adapter to the radio. Make sure that the battery icon animates.
3. Charge the radio for 13 hours then disconnect it from the adapter.

### ***Battery Level Display***

The battery icon at the bottom of the screen indicates the battery level (displayed as one of the following 5 levels) at all times

except while charging.



Fully  
Charged



Mostly  
Charged



Half Charged



Mostly Empty



Empty



**NOTE**

When **PTT** is pressed when the battery icon indicates Empty, an error tone sounds and transmission is disabled. Once at Empty, the unit will shutdown automatically after 60 seconds.

Recharge the batteries at any time. From empty, the batteries requires 13 hours to fully charge. For faster charging, turn off the radio.

Battery Life: 10 Hours (Typical)

## ATTACHING THE BELTCLIP

### ***To attach the belt clip:***

Slide the belt clip until it snaps into place.

### ***To remove the belt clip:***



Press and hold the belt clip lock down while simultaneously sliding it upward until it releases.

## OPERATION

In order to get the most out of your new radio, read this owner's manual completely before attempting to operate the unit.

## BASICS

### Power On/Off

1. Press and hold  to turn the radio ON. A channel number and battery level should appear on the display.
2. Press and hold  to turn the radio OFF.

### Volume

The volume level can be adjusted from 0 (no volume) to 15 (maximum volume).

Press **VOL ▲** or **VOL ▼** to increase or decrease the volume level. The current volume level flashes.

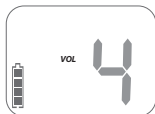

### Select a Channel

Press **CH ▲** or **CH ▼** to scroll through the channels individually. Press and hold **CH ▲** or **CH ▼** to scroll rapidly through the channel numbers. Refer to page 28 for a list of available channels and their corresponding frequencies and usage guidelines.

### Set Squelch

Use squelch to eliminate any annoying background noise when there are no signals present.



#### NOTE

Make sure to first select a channel not in use before setting the squelch.

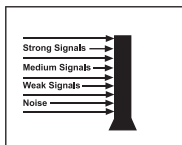

Think of the squelch control as a gate. If you increase the squelch level to maximum, it raises the “Squelch Gate” so only the strongest signals get through.

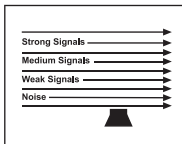

If you decrease the squelch level to minimum, it lowers the “Squelch Gate” to the extent that weak signals can get through.

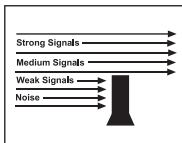

If unwanted weak and noisy signals are getting through, increase the squelch level (raise the “Squelch Gate”) to a medium level. Now only medium and strong signals get through.

S1 - minimum squelch

S2 - medium squelch

S3 - maximum/tight squelch

1. Press **SQL UIC**. SQL displays and the current squelch level flashes.
2. Press **SQL UIC** while the squelch level displays to change the squelch level to the next step (0 - 3, then repeating again from 0).
3. After 2 seconds the unit exits the squelch setting.



## TRANSMITTING AND RECEIVING

### Selecting Channel Modes

The radio uses U.S., Canadian, and International Marine channels (modes). Press and hold **SQL UIC** to change modes. Each time you press and hold **SQL UIC**, the mode indicator changes (*US* - United States; *CAN* - Canada; *INT* - International). Refer to page 28 for a list of the available channels and corresponding frequencies.

**NOTE**

Each time you change the UIC mode, Triple Watch, EMG CH16/CH9, WX mode, and WX Alert mode are canceled. The system does not remember these settings between modes.

Memory channels are saved to their specific UIC mode.

### ***Transmitting***

The radio can transmit for up to 3 minutes. *TX* displays when transmitting. After 3 minutes of continuous transmission, transmission is canceled and an error tone sounds.

The radio transmits at 1W; press ***BOOST*** to transmit at 3W.

### **Boosting Transmission Power**

1. Hold the radio approximately 2 inches in front of your mouth with the antenna at approximately 45° angle away from your head.
2. Press ***BOOST*** on the side of the radio to change the transmit power from Low (1W) to High (3W). Speak in a clear, normal, conversational voice.
3. When you have finished speaking, release ***PTT*** or ***BOOST*** to listen for a response. *TX* then disappears.
4. When the channel is clear, press and hold ***PTT*** or ***BOOST*** to transmit. *TX* displays again.

**NOTE**

When you press ***BOOST*** and the transmit power is low (LO - 1W), the radio transmits at maximum high power (HI - 3W) except for US channels 13, 17, 67, 75, 76, and 77, CAN channels 13, 15, 17, 20, 66A, 75, 76, and 77, and INT channels 15, 17, 75, and 76.

### ***Receiving***

Release ***PTT*** or ***BOOST*** to receive another party's transmissions to you.

## HOW IT WORKS

Your radio has three main operation modes: normal, scan, and weather.

Mode	What it does	Use it when you want to...	To turn it on/off
Normal	Monitors a single marine channel and lets you talk on that channel.	Monitor a channel or talk to another radio.	(default mode)
Scan	Monitors all the channels you save into memory.	Check a small group of regularly-used channels for traffic.	Press <b>SCAN MEM.</b>
Weather	Monitors the selected NOAA weather channel.	Hear the current or forecasted weather.	Press <b>WX ALERT.</b>

In addition to the three operation modes, your radio provides two different watch modes which you can activate during any operation mode. In the watch modes, the radio briefly checks for activity on a specific channel, then returns to its previous operation.

Watch mode	What it does	To turn it on/off
Weather Alert Watch	Checks the last-used weather channel for hazard alerts every 7 seconds.	Press and hold <b>WX ALERT</b> for 2 seconds.
Triple Watch	Checks channels 16 and 9 for activity every 2 seconds.	Press and hold <b>16/9 TRI</b> for 2 seconds.

 **Note: Private boats must monitor channel 16 whenever they are underway. Water-going vessels should have Triple Watch on at all times.**

## NORMAL MODE OPERATION

- To transmit, remove the radio from the charger, then press and hold the **PTT** key. Release the key when you are finished talking.
- For the best sound quality, hold the microphone about two inches from your mouth while you're talking.

- Press the **CH ▲** key to move up one channel at a time. Press and hold the key to scroll quickly up the channels.
- Press the **CH ▼** key to move down one channel at a time. Press and hold the key to scroll quickly down the channels.
- To change the transmit power, press the **H/L LOCK** key. The transmit power switches to the next transmit power each time you press this key.

### **Normal mode with Weather Alert Watch**

If you activate Weather Alert Watch while operating in normal mode, the radio checks the most recently used weather channel every seven seconds. If it detects a weather or other hazard alert, it will switch to that weather channel. (If you are transmitting or receiving an active transmission, the radio waits until the channel is clear or you finish your transmission before checking the weather channel.)

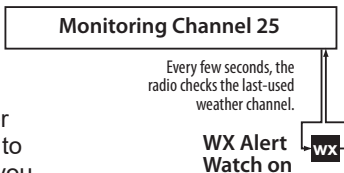

### **Normal mode with Triple Watch**

If you activate Triple Watch while operating in normal mode, the radio checks channels 9 and 16 every two seconds. The radio will not check channels 9 or 16 while you are actively transmitting; it waits until your transmission is finished and then checks the channels.

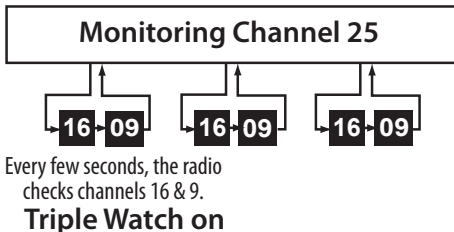

## SCAN MODE OPERATION

You can save channels into memory and then use scan mode to monitor those channels from lowest to highest. If the radio detects a signal on a channel, it stays on that channel as long as the signal is received; when the signal stops, the radio continues scanning.

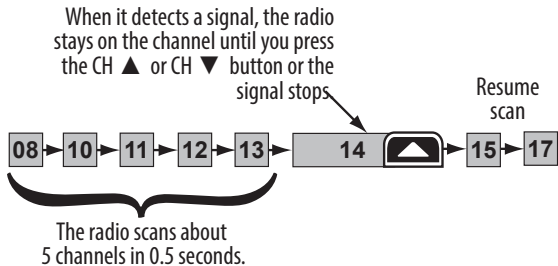

### Using the radio in scan mode

- To activate scan mode, press **SCAN MEM**.
- You must have at least two channels in memory to start a scan.
- To save a channel into memory, select the channel, then press and hold the **SCAN MEM** key. The **MEM** icon displays whenever you tune to that channel.
- To remove a channel from memory, set the radio to that channel, then press and hold the **SCAN MEM** key. The **MEM** icon no longer displays.
- When the radio stays on a channel, press **CH ▲** or **CH ▼** to leave that channel and resume scanning.
- To end the scan, press the **SCAN MEM** key again; the radio remains on the last scanned channel.

### Scan mode with Weather Alert Watch

If you activate Weather Alert Watch while in scan mode (press and hold **WX ALERT**), the radio checks the most recently-used weather channel every seven seconds, then continues

scanning the next channel in memory:

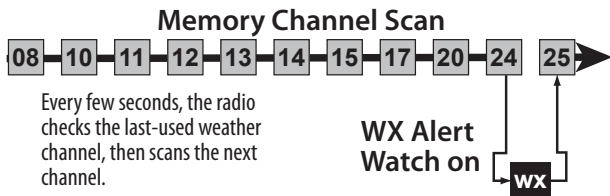

### ***Scan mode with Triple Watch***

If you activate Triple Watch (press and hold **16/9 TRI**) while operating in scan mode, the radio checks channels 9 and 16 every two seconds, then goes on to scan the next channel:

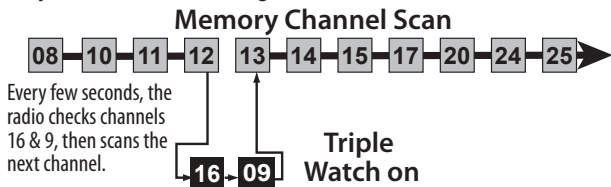

## **WEATHER MODE**

The NOAA weather channels cooperate with the FCC to alert you of other hazards besides weather (child abduction alerts, nuclear, biological, etc.). In weather mode, the radio monitors one of the nine NOAA weather channels. If any type of alert is received, the radio sounds an alert tone and the display blinks.

### ***Using the radio in weather mode***

- You cannot transmit while in weather mode.
- To enter weather mode, press the **WX ALERT** key.
- If the radio selects a WX Alert signal, it sounds an alert tone 3 times.

- To turn off the radio's alert tone, press any key.
- To cancel weather mode and return to the previous marine channel including emergency channels 16 and 9, press the **WX ALERT** key again.

### **Weather mode with Weather Alert Watch**

Because weather mode already monitors the weather channels, you don't need Weather Alert Watch to check the weather channel every seven seconds. If you activate Weather Alert Watch while operating in weather mode, it operates as a type of "sleep" mode; the radio stays on the weather channel and mutes the speaker. If an alert is detected, the radio sounds an alert tone and turns the speaker back on. This mode is very useful when you are anchoring for the night but want to keep informed of hazards.

### **Weather mode with Triple Watch**

If you activate Triple Watch while operating in weather mode, the radio checks the current marine channel, channels 9 and 16 every two seconds, and the current WX channel about every nine seconds.

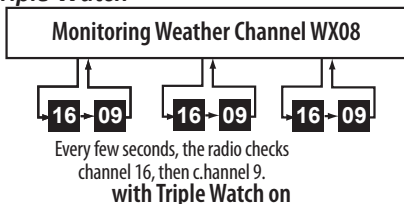

### **Emergency Channel 16/9**

While monitoring a channel (CH 20 in this example), press **16/9** to monitor CH 16.



Press **16/9** again to monitor CH 9.



Press **16/9** again to monitor the original channel (CH 20).



## Triple Watch

Triple Watch mode monitors channels 16 and 9 for a signal while you listen to the currently-selected channel. The marine radio checks channel 16 and 9 for activity every 2 seconds.

1. Press and hold **16/9 TRI** to activate Triple Watch. *TRI* displays.
2. Press and hold **16/9 TRI** again to exit Triple Watch. *TRI* disappears.



While in Triple Watch mode, you can change the currently selected channel using **CH ▲** or **CH ▼**.

## DROP-OUT DELAY

While scanning, the radio stops on channels when it receives a signal. When the received signal is over, there is a drop-out delay of 2 seconds for the return of the signal. After 2 seconds, if the signal does not return, the radio resumes scanning.

## BATTERY SAVE

This feature extends the battery life by switching the receiver circuit power on and off. Battery Save automatically activates during standby mode (RX mode without signal).

## BACKLIGHTING

The Liquid Crystal Display (LCD) is backlit for easy viewing at night or in low light situations. Backlighting automatically switches on every time a key is pressed (except **PTT** and **BOOST**) and off 10 seconds after the last key is pressed.

1. Press the Backlight icon (  ) and the current backlight level/color displays.
2. Press the icon again and the backlight level/color changes in the following order:

White High (default) - White Medium - White Low - Amber High - Amber Medium - Amber Low - White High, etc.

## ADJUST LCD CONTRAST

Adjust the LCD contrast to make the images on the LCD clearer and easier to see. You must first enter LCD contrast adjustment mode.

1. Turn off the radio, and then turn it on again while pressing and holding **16/9 TRI** and **WX ALERT**.
2. Press **VOL ▲** and **VOL ▼** to change the levels (0 - 31). The contrast level displays and blinks.

## KEYPAD LOCK

To prevent accidental entries, you can lock the keypad. Press and hold **H/L LOCK** until it beeps to activate Keypad Lock. **LOCK** displays on the LCD. When Keypad Lock is active, a warning beep sounds and **LOCK** blinks if you try to press any keys other than **PTT**, **BOOST**, or power.

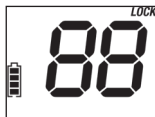

The radio retains Keypad Lock status even when you cycle power on/off. To unlock the keypad, press and hold **H/L LOCK** again. **LOCK** disappears.

## KEY BEEP

Key Beep is the tone that sounds when you press a key. To turn Key Beep on or off, press and hold the **CH ▲** or **CH ▼** key while turning the radio on.

When Key Beep is on, all key beeps are enabled. When Key Beep is off, all key beeps are disabled except WX Alert Tone.

## SPEAKER VIBRATION TONE

If the radio falls overboard into the water, you can trigger a tone to help remove water through the speaker. This tone vibrates the speaker and helps push water out the drain hole and speaker openings.

1. Press both **VOL ▲** and **VOL ▼** to activate this feature. The speaker vibrates and a tone sounds.
2. Press any key to turn off the tone.

## MAINTENANCE & TROUBLESHOOTING

Due to its rugged design, your radio requires very little maintenance. However, it is a precision electronic instrument, so you should follow a few precautions:

- If the antenna has been damaged, do not transmit except in an emergency situation. Transmitting with a defective antenna may cause further radio damage.
- You are responsible for continued FCC technical compliance of your radio.
- You should arrange for periodic performance checks with your Uniden dealer.

## COMMON QUESTIONS

Problem	Things to Try
The radio won't turn on.	Charge the radio.
The charging animation doesn't start.	<ul style="list-style-type: none"><li>• Don't charge the radio when the ambient temperature is below 32°F (0°C) or above 113°F (45°C).</li><li>• Make sure the charging contacts on the radio and charger are clean.</li><li>• Replace the batteries.</li></ul>
The radio won't transmit.	<ul style="list-style-type: none"><li>• Make sure you are not in Scan mode.</li><li>• Make sure you are not trying to transmit on a receive-only channel (see the channel lists starting on page 28).</li><li>• Check the battery power level; if it's low, charge the battery before trying to transmit.</li><li>• Make sure the duration of each transmission is less than 3 minutes.</li></ul>
I can't hear anything from the speaker.	Adjust the squelch level; it is probably too high. If the radio has fallen into water, activate the Speaker Vibration Tone (see page 24). The vibration will help remove water from the unit.

<b>Problem</b>	<b>Things to Try</b>
Noise comes out of the speaker all the time	Adjust the squelch level; it is probably too low.
I can transmit, but no one can hear me.	Check your UIC channel settings: does the area you are in use different channel assignments?
Where can I find my radio's serial number?	The serial number is on a plate inside the battery compartment.

## SPECIFICATIONS

<b>General</b>	
Channels	All US, International, and Canada marine channels
	10 Weather Channels
Frequency Control	PLL
Frequency Tolerance	Transmit: 0.5 PPM (at 25°C)
Operating Temperature	-4°F (-20°C) to +122°F (+50°C)
Antenna	Flexible Whip
Microphone	Built-in Electret type
Display	Liquid Crystal Display
Speaker	8 Ω 1W
Power Source	4 Rechargeable NiMH Batteries 950 mAh AAA x 4
Size (without antenna)	8.98 (H) x 2.52 (W) x 1.54 (D) inch
	228 (H) x 64 (W) x 39 (D) mm
Weight	8.53 oz (242g) (w/batteries)
<b>Transmitter</b>	
Frequency Range	156.050 ~ 161.6 MHz
Frequency Stability	± 5 PPM
Power Output	1W and 3W
Spurious Emissions	-34 dBm on Hi; -40 dBm on Lo
Current Drain	1000 mA (3W)

<b>Receiver</b>	
Type	Direct Conversion Super Heterodyne Phase Locked Loop system for Local Oscillator
Frequency Range	156.05 - 162.55 MHz
Sensitivity	0.28 $\mu$ V for 12 dB SINAD
Squelch Sensitivity	Threshold 0.22 $\mu$ V
Audio Frequency Response	+5.5 dB @ 500 Hz; -6.5 dB @ 2000 Hz
Adjacent Channel Selectivity	60 dB @ $\pm$ 25 kHz
Audio Output Power	0.5W @10% THD
Current Drain	Squelched: 60 mA; Max. Audio: 150 mA

# CHANNELS AND FREQUENCIES (MHZ)

## MARINE RADIO CHANNEL CHART

Ch No.	U	I	C	TX	RX	S/D	Channel Type/Name
01		x	x	156.050	160.650	D	Marine Operator
1001	X			156.050	156.050	S	Vessel Traffic System/Commercial
02		x	x	156.100	160.700	D	Marine Operator
03		x	x	156.150	160.750	D	Marine Operator
1003	X			156.150	156.150	S	US Gov't only; Coast Guard
04		x		156.200	160.800	D	Marine Operator
04A			x	156.200	156.200	S	Canadian Coast Guard
05		x		156.250	160.850	D	Marine Operator
05A			x	156.250	156.250	S	Vessel Traffic System
1005	X			156.250	156.250	S	Vessel Traffic System/Commercial
06	x	x	x	156.300	156.300	S	Inter-ship safety
07		x		156.350	160.950	D	Marine Operator
7A			x	156.350	156.350	S	Commercial
1007	x			156.350	156.350	S	Commercial
08	x	x	x	156.400	156.400	S	Commercial (International: Inter-Ship)
09	x	x	x	156.450	156.450	S	INT and CAN: Boater Calling Channel US: Non-Commercial
10	x	x	x	156.500	156.500	S	Commercial
11	x	x	x	156.550	156.550	S	Vessel Traffic System
12	x	x	x	156.600	156.600	S	Vessel Traffic System
13	x	x	x	156.650	156.650	S	Bridge to Bridge US and CAN: 1W
14	x	x	x	156.700	156.700	S	Vessel Traffic System
15	x			Inhibit	156.750	Receive Only	Environmental

Ch No.	U	I	C	TX	RX	S/D	Channel Type/Name
15		x	x	156.750	156.750	S	Environmental INT and CAN: 1W
16	x	x	x	156.800	156.800	S	Distress, Safety, Calling
17	x	x	x	156.850	156.850	S	Government Maritime Control CAN: State Control
18		x		156.900	161.500	D	Port Operation, 1W
18A			x	156.900	156.900	S	Commercial
1018	x			156.900	156.900	S	Commercial
19		x		156.950	161.550	D	Port Operation, Ship Movement
19A			x	156.950	156.950	S	Canadian Coast Guard
1019	x	x		156.950	156.950	S	Commercial
2019		x		161.550	161.550	S	
20	x	x	x	157.000	161.600	D	Port Operations CAN: 1 Watt Only
1020	x	x		157.000	157.000	S	Port Operations
2020		x		161.600	161.600	S	
21		x		157.050	161.650	D	Port Operations
21A			x	157.050	157.050	S	Canadian Coast Guard
21B*			x	INHIBIT	161.650	S	Continuous Marine Broadcast (CMB) Service
1021	x			157.050	157.050	S	Coast Guard Only
22		x		157.100	161.700	D	Port Operations, Ship Movement
22A			x	157.100	157.100	S	Canadian Coast Guard
1022	x			157.100	157.100	S	US Coast Guard
23		x	x	157.150	161.750	D	Marine Operator
23B*			x	INHIBIT	161.750	S	CMB Service
1023	x			157.150	157.150	S	US Coast Guard Only
24	x	x	x	157.200	161.800	D	Marine Operator
25	x	x	x	157.250	161.850	D	Marine Operator
25B*			x	INHIBIT	161.850	S	CMB Service

Ch No.	U	I	C	TX	RX	S/D	Channel Type/Name
26	x	x	x	157.300	161.900	D	Marine Operator
27	x	x	x	157.350	161.950	D	Marine Operator
28	x	x	x	157.400	162.000	D	Marine Operator
28B*			x	INHIBIT	162.000	S	CMB Service
60		x	x	156.025	160.625	D	Marine Operator
61		x		156.075	160.675	D	Marine Operator
61A			x	156.075	156.075	S	Canadian Coast Guard
1061	x			156.075	156.075	S	Public Coast: Coast Guard East Coast: Commercial Fishing Only
62		x		156.125	160.725	D	Marine Operator
62A			x	156.125	156.125	S	Canadian Coast Guard
63		x		156.175	160.775	D	Marine Operator
63A			x	156.175	156.175	S	Port Operations
1063	x			156.175	156.175	S	VTS
64		x	x	156.225	160.825	D	Marine Operator
64A			x	156.225	156.225	S	Port Operation
1064	x			156.225	156.225	S	Public Correspondence (Marine Operator) Port Operation, Ship Movement
65		x		156.275	160.875	D	Marine Operator
65A			x	156.275	156.275	S	Port Operations
1065	x			156.275	156.275	S	Port Operation
66		x		156.325	160.925	D	Marine Operator
66A			x	156.325	156.325	S	Port Operations Canada: 1 Watt Only
1066	x			156.325	156.325	S	Port Operations
67	x	x	x	156.375	156.375	S	Bridge-to-Bridge, 1W
68	x	x	x	156.425	156.425	S	Non-Commercial
69	x	x	x	156.475	156.475	S	Non-Commercial
70	x	x	x	Inhibit	156.5250	DSC Only	DSC

Ch No.	U	I	C	TX	RX	S/D	Channel Type/Name
71	x	x	x	156.575	156.575	S	Non-Commercial
72	x	x	x	156.625	156.625	S	Non-Commercial US: Non-Commercial, Ship-to-Ship
73	x	x	x	156.675	156.675	S	Port Operations
74	x	x	x	156.725	156.725	S	Port Operations
75	x	x	x	156.775	156.775	S	Port Operations (1 Watt Only)
76	x	x	x	156.825	156.825	S	Port Operations (1 Watt Only)
77	x	x	x	156.875	156.875	S	Port Operations US and INT: Ship to Ship US and CAN: 1 Watt Only
78		x		156.925	161.525	D	Port Operations
78A			x	156.925	156.925	S	Non-Commercial, Inter-Ship
1078	x	x		156.925	156.925	S	Non-Commercial
2078		x		161.525	161.525	S	
79		x		156.975	161.575	D	Port Operations
79A			x	156.975	156.975	S	Commercial, Inter-Ship
1079	x	x		156.975	156.975	S	Commercial
2079		x		161.575	161.575	S	
80		x		157.025	161.625	D	Port Operations
80A			x	157.025	157.025	S	Inter-Ship
1080	x			157.025	157.025	S	Commercial
81		x		157.075	161.675	D	Port Operations
81A			x	157.075	157.075	S	Canadian Coast Guard
1081	x			157.075	157.075	S	Government
82		x		157.125	161.725	D	Port Operations
82A			x	157.125	157.125	S	Canadian Coast Guard
1082	x			157.125	157.125	S	Government
83		x		157.175	161.775	D	Port Operations
83A			x	157.175	157.175	S	Canadian Coast Guard
83B*			x	INHIBIT	161.775	S	Canadian CG Continuous Marine Broadcast (CMB) Service

Ch No.	U	I	C	TX	RX	S/D	Channel Type/Name
1083	x			157.175	157.175	S	Coast Guard
84	x	x	x	157.225	161.825	D	Marine Operator
85	x	x	x	157.275	161.875	D	Marine Operator
86	x	x	x	157.325	161.925	D	Marine Operator
87	x	x	x	157.375	157.375	S	Marine Operator
88	x	x	x	157.425	157.425	S	U: Commercial (Ship-to-ship) I: Marine Operator C: Port Operation

\* = New Channel, Continuous Marine Broadcast (CMB) Service

### ***Weather Channels and Frequencies (US and CAN)***

Ch No.	RX Freq	Name on Display
WX01	162.5500	162.550 MHz
WX02	162.4000	162.400 MHz
WX03	162.4750	162.475 MHz
WX04	162.4250	162.425 MHz
WX05	162.4500	162.450 MHz
WX06	162.5000	162.500 MHz
WX07	162.5250	162.525 MHz
WX08	161.6500	161.650 MHz
WX09	161.7750	161.775 MHz
WX10	163.2750	163.275 MHz

# REGULATIONS AND SAFETY WARNINGS

**WARNING!** Read this information before using the radio.

## RBRC Information

As part of our commitment to protect the environment and conserve natural resources, Uniden voluntarily participates in an RBRC® industry program to collect and recycle used Ni-MH batteries within the US.

Please call for information on Ni-MH battery recycling in your area. (RBRC® is a registered trademark of the Rechargeable Battery Recycling Corporation.)



## MARITIME RADIO SERVICES OPERATION

**Warning!** This transmitter will operate on channels/frequencies that have restricted use in the United States. The channel assignments include frequencies assigned for exclusive use of the U.S. Coast Guard, use in Canada, and use in international waters. Operation on these frequencies without proper authorization is strictly forbidden. See page 28 for tables of the available channels and their uses. If you are still not certain which channels to use, see the FCC maritime radio page at the FCC website or contact the FCC Call Center. For individuals requiring a license, such as commercial users, you should obtain a license application from your nearest FCC field office (for US users) or Industry Canada (for Canadian users).

## BASIC RADIO GUIDELINES

You should familiarize yourself with the rules on marine radios and be aware of which rules apply to your boat. Complete guidelines for all ship and marine radio types can be found at the US Coast Guard website under the topic Radio Info for Boaters. Here are a few guidelines that affect nearly all boaters:

- If you have a VHF radio on your boat, you must maintain a watch on channel 16 (156.800 MHz) whenever the radio is not being used to communicate. Starting in 2004, if a radio is carried, it must be on and set to channel 16 whenever your boat is underway.
- If you hear a distress call, wait a few minutes to let a shore station or Coast Guard vessel respond. If no other station has responded after 5 minutes, you must respond to the distress call.
- Do not make false mayday or distress calls as a prank or to test your radio. (This is essentially like making a false 9-1-1 call; you may be subject to fines.)

## FCC/IC Information

- Certification: FCC Part 15 or I.C. RSS
- Output Power: 3W
- Emission: 16K0F3E
- Transmitter Frequency Range: 156.05 ~161.6 MHz

This device complies with Industry Canada licence-exempt RSS standard(s). Operation is subject to the following two conditions: (1) this device may not cause harmful interference, and (2) this device must accept any interference received, including interference that may cause undesired operation.

Unauthorized changes or modifications to this equipment may void compliance with I.C. Rules. Any change or modification must be approved in writing by Uniden.

Changes or modifications not approved by Uniden could void the user's authority to operate the equipment.

## **FCC RF Exposure Information**

In August 1996 the Federal Communications Commission (FCC) of the United States with its action in Report and Order FCC 96-326 adopted an updated safety standard for human exposure to radio frequency electromagnetic energy emitted by FCC regulated transmitters. Those guidelines are consistent with the safety standard previously set by both U.S. and international standards bodies. The design of the radio complies with the FCC guidelines and these international standards.

Never allow children to operate the radio without adult supervision and the knowledge of the following guidelines.

**WARNING!** It is up to the user to properly operate this radio transmitter to insure safe operation. Do not exceed 50% PTT Duty Factor. Do not use the radio with a damaged antenna. If a damaged antenna comes into contact with the skin, a minor burn may result. Please contact your local dealer for a replacement antenna.