

Whitecap			
Units	INCHES	View	
P/N	6006-A		20170813

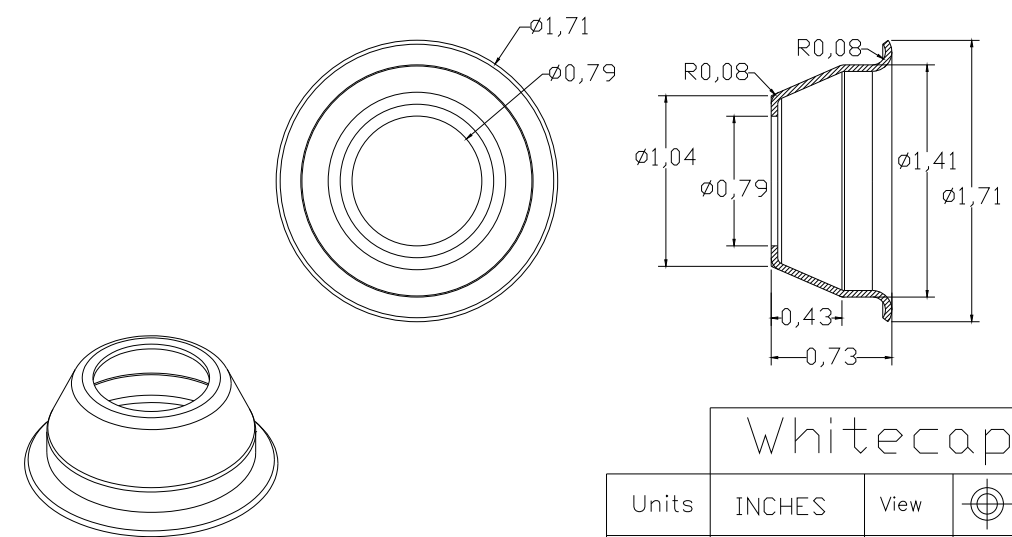
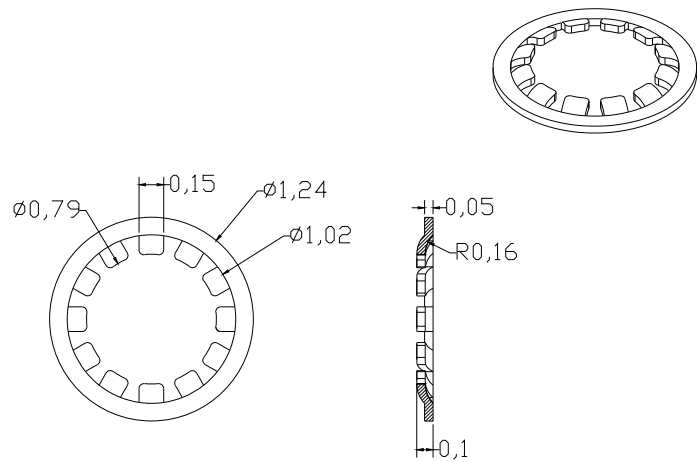
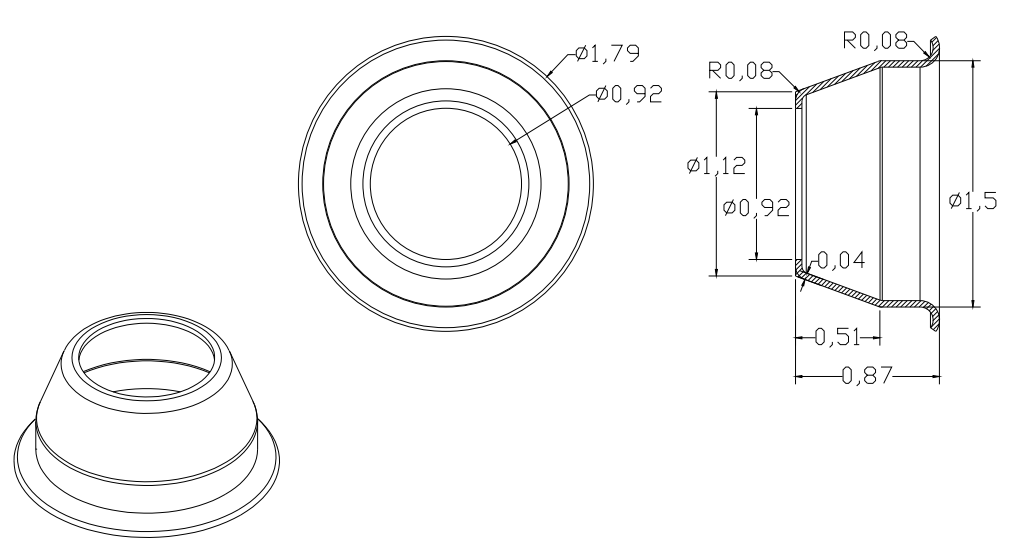
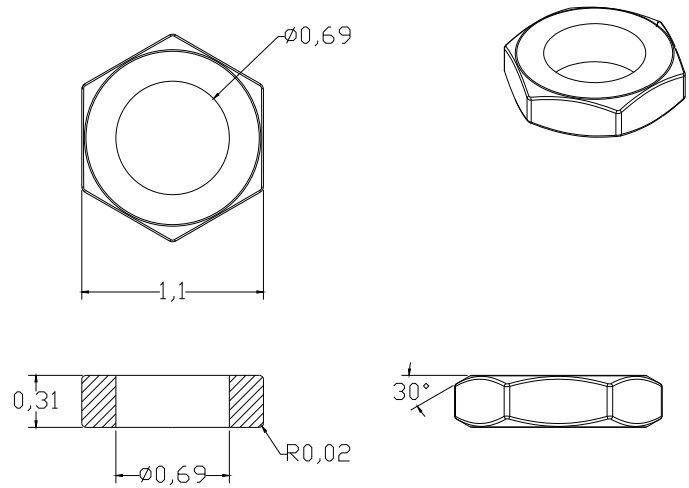

Whitecap

Units	INCHES	View	
P/N	6006-B		20170813