

Smart choice for power

xantrex



1000
1000i
1800
1800i

Owner's Manual

**Xantrex Prosine
Sine Wave Inverter
1000/1800**

Important Safety Instructions

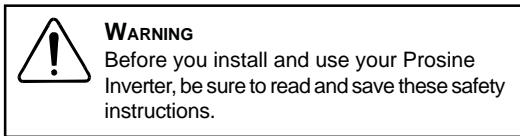

General Safety Precautions

1. **SAVE THESE INSTRUCTIONS.** This OWNER'S MANUAL contains important safety and operating information for the Prosine Inverter.
2. Do not expose the Prosine Inverter to rain, snow, spray, bilge or dust. To reduce risk of fire hazard, do not cover or obstruct the ventilation openings. Do not install the Prosine Inverter in a zero-clearance compartment. Overheating may result.
3. Do not use attachments not recommended or sold by Xantrex. Doing so may result in a risk of fire, electric shock, or injury to persons.
4. The Prosine Inverter is designed to be permanently connected to your DC electrical systems (and for hardwire versions, permanently connected to your AC electrical system). To ensure adherence to proper electrical wiring regulations all wiring must be done by a certified technician or electrician.
5. To avoid a risk of fire and electric shock, make sure that existing wiring is in good electrical condition; and that wire size is not undersized. Do not operate the Prosine Inverter with damaged or substandard wiring.
6. Do not operate the Prosine Inverter if it has received a sharp blow, been dropped, or otherwise damaged in any way. If the Prosine Inverter has been damaged, refer to Section 6 of this manual.
7. Do not disassemble the Prosine Inverter; refer to Section 6 of this manual for instructions on obtaining service for the Prosine Inverter. Attempting to service the unit yourself may result in a risk of electrical shock or fire.

8. To reduce risk of electrical shock, disconnect the DC power (and AC power if applicable on hardwire versions) from the Prosine Inverter before attempting any maintenance or cleaning or working on any equipment and circuits connected to the Prosine Inverter. Turning off controls will not reduce this risk.
9. **Grounding:** The Prosine Inverter must be provided with an equipment-grounding conductor connected to the AC input ground terminal. Grounding and all other wiring must comply with local codes and ordinances.
10. For marine applications, special installation codes may apply. For example, in the U.S., the installation shall comply with the United States Coast Guard Electrical Regulations (33CFR183, Sub part 1).

Explosive Gas Precautions

1. This equipment contains components which can produce arcs or sparks. To prevent fire or explosion do not install in compartments containing batteries or flammable materials or in locations which require ignition protected equipment. This includes any space containing gasoline-powered machinery, fuel tanks, or joints, fittings, or other connection between components of the fuel system.
2. Working in the vicinity of a lead-acid battery is dangerous. Batteries generate explosive gases during normal battery operation.
3. To reduce the risk of battery explosion, follow these instructions and those published by the battery manufacturer and the manufacturer of the equipment in which the battery is installed.

Precautions When Working With Batteries

1. Someone should be within range of your voice or close enough to come to your aid when you work near a lead-acid battery.
2. Have plenty of fresh water and soap nearby in case battery acid contacts skin, clothing, or eyes.
3. Wear complete eye protection and clothing protection. Avoid touching eyes while working near batteries.
4. Clean battery terminals before making connections. Wear eye protection to keep corrosion from coming in contact with eyes.
5. If battery acid contacts skin or clothing, wash immediately with soap and water. If acid enters eye, immediately flood eye with running cold water for at least 20 minutes and get medical attention immediately.
6. NEVER smoke or allow a spark or flame in vicinity of battery or engine.
7. Do not drop a metal tool on the battery. The resulting spark or short-circuit on the battery or other electrical part may cause an explosion.
8. Remove personal metal items such as rings, bracelets, necklaces, and watches when working with a lead-acid battery. A lead-acid battery produces a short-circuit current high enough to weld a ring or the like to metal, causing a severe burn.

1. Introduction

Thank you for your purchase of this Prosine Sine Wave Inverter. As a high quality, true sine wave output inverter, you can expect exceptional performance and years of dependable operation. The true sine wave AC output from the inverter ensures all AC loads operating from the unit perform efficiently and correctly. Since these loads were designed to operate from true sine wave voltage, you can expect these loads to operate the same as if operating from grid/utility supplied power. In some cases, the true sine wave output from the Xantrex inverter is even superior to the power supplied by your utility company.

To get the most out of your Prosine Inverter, carefully read and follow the instructions in this guide. Pay special attention to the Important Safety Instructions and to the **CAUTION** and **WARNING** statements found throughout the manual and on the product. Please retain all packaging.

Should you have any questions before, during, or after installation, please contact Xantrex.

1.1 Prosine Inverter Key Features

Please record the following information if you need to contact Xantrex for servicing of the unit.

Serial No.: _____

Place of purchase: _____

Date of purchase: _____

The Prosine Inverter utilizes advanced high frequency switching technology in the power conversion process. The circuits are similar to those used in power supplies for computers and other electronic equipment. This technology offers several benefits:

- Light weight: for easy installation

- Totally silent: for quiet operation
 - High surge capability: for “hard-to-start” AC loads
- See Section 10 (Specifications) for complete product specifications.

1.1.1 Inverter Function

When connected properly and the power switch is turned to the (I) position, the inverter draws power from a battery and delivers a true sine wave AC output voltage. If the battery voltage is within the operating range of the unit, the inverter will continue to deliver AC power to the loads connected. High and low battery shutdowns will engage if the battery voltage falls out of the specified range of operation (10–16 VDC on 12 V models, 20–32 VDC on 24 V models).

1.1.2 Control Panel

The Control Panel displays operating information so you can monitor the status of the Inverter and your batteries.

This panel can be removed and re-attached in different orientations so the information is directed at you in the most convenient fashion, for all recommended mounting



WARNING

Note that in (⓪) (Bypass) position the front panel switch does NOT turn off all voltages inside the unit. This control only deactivates the AC conversion circuitry. On AC hardwire/transfer relay versions any utility voltage present on the AC input terminals will be present on the AC output terminals.

configurations. With the optional Interface Panel, the display can be fully removed from the base chassis and remotely located in the place of your choice (e.g. on the dash of your vehicle).

1.1.3 Automatic Transfer Switch

Your Prosine Inverter may be equipped with a transfer relay if specified prior to purchase. The transfer relay serves two purposes: 1) allows the AC output of the inverter to be wired into an existing AC system as a source of power and 2) allows the Prosine Inverter to automatically become the source of power should your utility source fail.

When utility AC power fails, the transfer relay is de-energized and the load is automatically transferred to the inverter output within 20–30 milliseconds. With the POWERSAVE feature enabled (recommended for reducing standby power consumption), AC output from the inverter may be delayed for up to 2½ seconds. Once AC utility is restored, the relay energizes and the load is automatically reconnected to AC utility.

Identifying Models With Transfer Switches

1) Check the UPC code on the product box. Units with transfer switches have UPC codes that end with these five digits:

Model 1000/1000i	Model 1800/1800i
61084	61884
61074	61874
61052	61852
61008	61808
61002	61802

2) If there is an AC outlet on the front of the unit, it is not equipped with an internal transfer switch.

3) For Prosine Inverters with hardwire connections, you can identify whether your unit has an internal transfer switch by removing the cover on the AC wiring compartment and checking the label above the terminal block inside.

If your unit has a label similar to one of these two labels, it has an internal transfer switch:

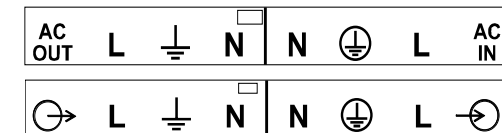

Units with this label do not have an internal transfer switch:



2. Installation



WARNING

Review the Important Safety Instructions found at the beginning of this manual and read this entire section, paying particular attention to the CAUTION and WARNING statements, before proceeding with the installation.

This section contains instructions for installing the Xantrex Prosine Inverter. After securing the unit and making wiring connections, do not turn the unit on. Proceed to the next section of the manual which provides operating instructions.

2.1 Requirements for Installation



CAUTION

The Prosine Inverter is designed to be permanently connected to your DC electrical system. When Configured as an AC hardwire version, the inverter is also designed to be permanently connected to your AC electrical system. To ensure adherence to proper electrical wiring regulations, all wiring must be done by a certified technician or electrician.

Installation Regulations: Depending on the type of location in which you are installing the Prosine Inverter, there are different codes and regulations that the installation must meet such as your national and local electrical codes for residential installations. Other examples of codes and regulations for North American installations include:

- US Coast Guard and ABYC requirements for installations on marine vessels
- RV Industry Association (RVIA), CSA, and UL requirements for installations in recreational vehicles.

It is the installer's responsibility to ensure that all applicable installation requirements are met.

What You Need to Install the Prosine Inverter

You need the following tools and hardware to properly install the inverter:

- wire stripper
- mounting screws/bolts (1/4" or 6mm diameter screws)
- small flat blade screwdriver (for hardwire versions)
- small Phillips screwdriver
- wrench for DC terminals (1/2" or 13mm)
- AC wiring for hardwire configured models (see AC wiring section for details)
- DC cables (see DC wiring section for details)
- Wire connectors and crimp tool for your DC cables
- AC and DC disconnects and over-current protective devices (see section 2.4.1 for details)

2.2 Locating the Prosine Inverter

The inverter utilizes complex electronic circuits, and although design precautions have been made for protection of these circuits, they can be susceptible to damage from use in extreme environments. The Prosine Inverter should only be installed in a location that meets the following requirements:

- **Dry:** do not allow water or other fluids to drip or splash on the Prosine Inverter. Do not mount the inverter in an area subject to splashing or dripping water or bilge.
- **Cool:** normal ambient air temperature should be between 0°C (32°F) and 25°C (77°F)—the cooler the better within this range. Refer to the operating temperature information in section 9 (specifications) for more details.
- **Ventilated:** allow at least 5 inches (13 cm) of clearance all around the unit. Ensure the ventilation openings on the unit are not obstructed. If mounting in a compartment, ventilate with louvers or cut-outs.
- **Safe:** do not install the Prosine Inverter in the same compartment as batteries or in any compartment capable of storing flammable liquids such as gasoline. Do not install the inverter in an engine compartment or other location where ignition protected equipment is required.
- **Dust-free:** do not install the Prosine Inverter in a dusty environment where either dust, wood particles or other filings/shavings are present. These can be pulled into the unit when the cooling fan is operating.
- **Close to AC junction box:** avoid the use of extended wire lengths if possible.

- **Close to battery/batteries:** Avoid excessive cable lengths but do not install the Prosine Inverter in the same compartment as batteries. Use the recommended wire lengths and sizes (see section 2.4.4). Also do not mount the inverter where it will be exposed to the gases produced by the battery. These gases are very corrosive and prolonged exposure will damage the inverter.

- **Protected from battery acid:** never allow battery acid to drip on the Prosine Inverter or its wiring when reading specific gravity or filling the battery.

2.3 Mounting the Prosine Inverter

Before mounting the Prosine Inverter, test the chosen location for adequate space around the unit to allow for connections and ventilation. Mounting hardware should be corrosion resistant and 1/4" or 6mm diameter screws. Your mounting system should be able to support three times the weight of the inverter, which weighs approximately 16 lbs (7.3Kg). The more clearance for ventilation around the unit, the better the performance. At a minimum, have 5" of free space on all sides of the inverter.

To mount the Prosine Inverter

1. Mount the Prosine Inverter on either a horizontal or vertical surface (such as a bulkhead) using the mounting holes provided. For secure, permanent mounting, use all eight mounting holes. To meet regulatory requirements, the inverter must be mounted in one of the three orientations shown.

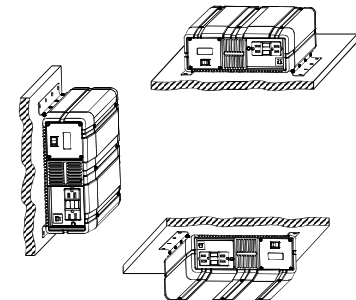

Figure 1. Approved orientations for inverter mounting

- Remove and re-attach the front panel depending on the orientation of the base unit itself. For example, if the unit is mounted on a vertical surface, you may want to remove the panel and attach it so it is again readable horizontally. This can be done by removing the four screws, taking the panel out of the housing, rotating the panel and reattaching the panel to the base unit. Be sure to re-install all four screws.
- The front panel can also be remotely located away from the base chassis. Simply remove the panel from the face of the unit, install the interface panel option (purchased separately) and connect the 30 ft. (9 m) extension cord. The cord can then be run to the location where the panel is to be mounted, and attached to the panel. The unit can now be controlled and monitored from the location of your choice. Do not remotely mount the display panel without purchasing the Interface Panel option and properly installing this panel on the inverter. The Interface Panel significantly reduces radiated interference generated along the length of the cable, decreasing the chance of resulting interference with other equipment.

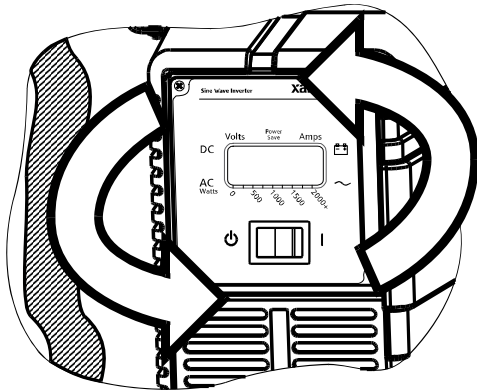



Figure 2. Control panel attachment

2.4 Wiring the Prosine Inverter



WARNING
Fire and shock hazard. Make sure wiring is disconnected from all electrical sources before handling. All wiring must be done in accordance with local and national electrical wiring regulations by a certified electrician or technician.



For units equipped with an AC outlet:

If your Prosine Inverter is equipped with an AC outlet on the front, then you will be mainly interested in the DC wiring instructions that follow (section 2.4.4). Once your DC connections and ground wiring connection are complete, the unit is ready to deliver AC power.

For AC hardwire versions:

If your unit is equipped with an AC hardwire terminal strip, (with or without transfer relay) then the following AC wiring instructions are important for you to read through. When hardwire configured, the inverter manages all AC power and therefore must be wired in between any utility connection and distribution panel.

As a starting point for the wiring instructions, here is a brief summary of the wiring sequence for hardwire configured inverters. Please thoroughly read the remainder of the wiring instructions (section 2.4.2) which details each wiring step and follows the Input and Output Protection section:

- Ensure the  control panel switch is in the  position. For those hardwire equipped models with a transfer relay, connected AC source (INPUT) power will be passed through the inverter making the output terminal and connected wiring live. This is the case even with the control panel switch in the  position so ensure all power is disconnected at its source.

- Connect AC input wiring, AC output wiring, Chassis Ground, DC positive cable and finally, DC negative cable in that order.
- Connect each circuit to its source.

2.4.1 Input and Output Protection

In order to meet CSA, UL, and electrical code requirements, the AC and DC inputs and outputs of the Prosine Inverter must be provided with overcurrent protection such as a circuit breaker or fuse, and with a disconnect device, as follows: (note the “AC Input” and “AC Output” information below only applies to units equipped with AC hardwire terminal strips, not AC output receptacle equipped versions).

DC Input: Protection for the DC wiring (an inline fuse /circuit breaker) is needed as close as possible to the battery to protect the wiring from your batteries to the Prosine Inverter. The current rating of this DC fuse or circuit breaker must be large enough to allow the inverter to operate your loads, but if the rating is too high, electrical codes will require you to use larger DC cables than you would otherwise have to. The fuse or circuit breaker must be rated and approved for use on minimum 12V or 24V DC circuits as applicable by the model of your inverter. Fuses or circuit breakers rated only for AC service are not suitable for use on DC circuits and may pose a hazard. The wire size used between the Prosine Inverter and the fuse or circuit breaker must be sized to match the fuse or circuit breaker’s current rating, in accordance with the electrical codes or regulations applicable to your installation (see Table 4).

AC Input: The installation must provide over-current protection for the AC input circuit. The circuit breaker or fuse used must be rated and approved for use on 120VAC branch circuits for 120V models and for 230VAC branch circuits for 230V models. The wire size used between the breaker and the Prosine Inverter input must be sized to match the circuit breaker, in accordance with the electrical codes or regulations applicable to your installation. Refer to Table 1 for sizing information.

AC Output: The circuit breaker or fuse used must be rated and approved for use on 120V AC branch circuits for 120V models and for 230VAC branch circuits for 230V models. The wire size used between the Prosine Inverter output and the breaker, and between the breaker and your loads, must be sized to match the circuit breaker's rating, in accordance with the electrical codes or regulations applicable to your installation. Refer to Table 1 for sizing information.

Disconnect devices: Since circuit breakers can be turned off and fuses can be removed from the circuit, either type of device will also meet the requirement for a disconnect device in each of the above circuits. Note that the required disconnect device is not intended for disconnection under load, it is only meant to be a way to isolate the Prosine Inverter from the input and output power sources.

2.4.2 Making AC Wiring Connections

Again, this section applies to those models configured with an AC hardwire terminal strip. As mentioned previously, your AC wiring must be sized to match the current rating of the AC breakers you provide on the input and output AC circuits in accordance with the electrical codes or regulations applicable to your installation. Table 1 is based on the U.S. National Electrical Code (1999), the Canadian Electrical Code (1998), and European wiring practices (for 230V models). There may be other codes and regulations applicable to your installation.

MODEL	AC INPUT and AC OUTPUT	
	Required Breaker Rating	Required Wire Size
1000 - 12/24 V 1800 - 12/24 V	20 A max.	12 AWG
1000i - 12/24 V 1800i - 12/24 V	10 A max.	1.0 - 2.5mm ²

Table 1. Circuit Breakers and Wire Sizing

Note that there is no difference between the recommendations for the 1000 and 1800 models. This is because the bypass rating of these products is the same (i.e. 15A for 1000 and 1800 and 10A for 1000i and 1800i).

Figure 3 may be a useful reference as it illustrates the AC wiring connection terminals for Prosine Inverter models that are AC hardwire configured.

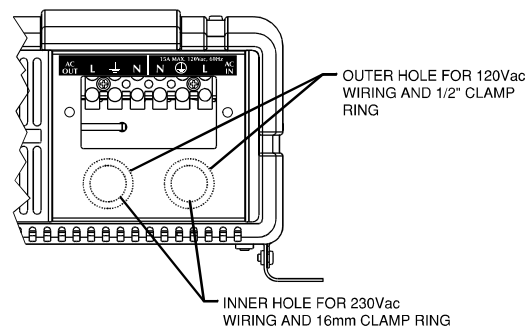



Figure 3. AC wiring terminals (hardwire versions only)



WARNING
Shock Hazard. Before proceeding further, ensure that the Prosine Inverter is NOT connected to any batteries, and that all wiring is disconnected from any electrical sources. Do not connect the output terminals of the inverter to an incoming AC source.

AC Wiring should be connected in the following order:

1. AC INPUT (source)
2. AC OUTPUT (load)

To make AC wiring connections:

1. The AC wiring compartment is located on the right-hand side of the Prosine Inverter when looking at

the front of the unit. Remove the AC wiring compartment cover to gain access to the AC terminal strip inside.

2. Remove the knockouts from the cover of the wiring compartment to create holes for your cable clamps (see Figure 3).
3. Run the three conductor AC INPUT (source) wiring through a cable clamp and into the wiring compartment, via the knockout on the right side of the front panel. Connect the AC INPUT ground wire first to the ground terminal (ground symbol with circle around it), and then connect the AC INPUT line and neutral wires to the corresponding Prosine Inverter AC input terminals. Refer to Table 2 for typical colour coding and terminal identification.
4. In a similar manner, connect the AC OUTPUT (load) wiring to the Prosine Inverter AC output terminals (connect the output ground to the ground terminal identified by the symbol with no circle around it). Terminal to wiring connections should be done as shown in Table 2.

TERMINAL	AC WIRE COLOR	
	120 VAC (N. American)	230 VAC (European)
LINE (L)	Black	Brown
NEUTRAL (N)	White	Blue
GROUND	Green or bare copper	Green/Yellow or bare copper

Table 2. AC Terminal and Wiring Identification

5. After wiring, double check and review all connections to make sure the wires are in the correct terminals and the terminals are tight (the recommended torque is 7.5 in-lbs., 9.8 Nm).

AC Safety Grounding: During the AC wiring installation, AC input and output ground wires are connected to the inverter. The AC input ground wire must connect to the incoming ground from your AC utility source. The AC output ground wire should go to the grounding point for your loads (e.g. a distribution panel ground bus).

Neutral Grounding:

- a) **120V models:** The neutral conductor of the AC output circuit of the Prosine Inverter is automatically connected to the safety ground during inverter operation. This conforms to National Electrical Code requirements that separately derived AC sources (such as inverters and generators) have their neutral conductors tied to ground in the same way that the neutral conductor from the utility is tied to ground at the AC breaker panel. For models configured with a transfer relay, when AC utility power is present and the Prosine Inverter is in bypass mode, this connection (neutral of the inverter’s AC output to input safety ground) is not present so that the utility neutral is only connected to ground at your breaker panel, as required.
- b) **230V models:** There is no connection made inside the Prosine Inverter from either of the line conductors (line or neutral) to the safety ground.

2.4.3 Ground Fault Circuit Interrupters (GFCIs)

Installations in Recreational Vehicles (for North American approvals) will require GFCI protection of all branch circuits connected to the AC output of the hardware terminal equipped Prosine Inverters. In addition, electrical codes require GFCI protection of certain receptacles in residential installations. While the true sine wave output of the Prosine Inverter is equivalent to the waveform provided by utilities, compliance with UL standards requires us to test and recommend specific GFCIs.

Xantrex has tested the following GFCI-protected 15 A receptacles and found that they functioned properly when connected to the AC output of the inverter:

Manufacturer	Model
LEVITON	6599/701
LEVITON	6598/722*
EAGLE	Shock Sentry
PASS & SEYMOUR	1591-WCN
HUBBELL	GF252GYA
BRYANT	GFR52FTI
BRYANT	GFR82FTI**

* With Line/Load inversion check & indicator light
 ** Hospital Grade

2.4.4 Making DC Wiring Connections

Follow this procedure to connect the battery cables to the DC input terminals on the Prosine Inverter. Your cables should be as short as possible (ideally, less than 10 ft./3 m) and large enough to handle the required current, in accordance with the electrical codes or regulations applicable to your installation. Cables that are not an adequate gauge (too narrow) or are too long will cause decreased inverter performance such as poor

V = I x R Voltage = Current x Resistance								
		Inverter Output (W)	500	1000	1500	2000	2500	3000
		Current (A)	50	100	150	200	250	300
Wire Gauge (AWG)	Resistance (ohms/ft) @ 25°C	Voltage Drop per ft.	Voltage Drop per ft.	Voltage Drop per ft.	Voltage Drop per ft.	Voltage Drop per ft.	Voltage Drop per ft.	Voltage Drop per ft.
4/0	0.000050	0.0025	0.0050	0.0075	0.0100	0.0125	0.0150	
3/0	0.000063	0.0032	0.0063	0.0095	0.0126	0.0158	0.0189	
2/0	0.000079	0.0040	0.0079	0.0119	0.0158	0.0198	0.0237	
0	0.000100	0.0050	0.0100	0.0150	0.0200	0.0250	0.0300	
1	0.000126	0.0063	0.0126	0.0189	0.0252	0.0315	0.0378	
2	0.000159	0.0080	0.0159	0.0239	0.0318	0.0398	0.0477	
3	0.000201	0.0101	0.0201	0.0302	0.0402	0.0503	0.0603	
4	0.000253	0.0127	0.0253	0.0380	0.0506	0.0633	0.0759	

Table 3. Voltage drop per ft of DC cable

surge capability and frequent low input voltage warnings and shutdowns.

These low input voltage warnings are due to DC voltage drop across the cables from the inverter to the batteries. The longer and narrower these cables, the greater the voltage drop. Table 3 shows voltage drop per foot of cable, at various power output levels.

For example, if the 1800 Inverter is 10 ft. from your battery, is operating at 2000 watts, and is improperly connected with #4AWG wire, then you can expect a voltage drop per foot of 0.0506 V. Total cable length is actually 20 ft., not 10 ft., since the cable length is measured from the battery to the inverter and back. Therefore, multiply 0.0506 V by 20 to get a total voltage drop of 1.012 V. If your battery voltage is only 11.2 VDC, then the actual voltage at the inverter is 10.188 (11.2 V–1.012 V) because of this significant voltage drop. The Prosine Inverter will either be in low input voltage warning or shutdown in such a condition. In high current draw and surge situations, the unit may go into low input voltage shutdown if the cables are too small and too long.

Increasing your DC cable size will help improve the situation. With cables sized correctly, and using a #0 AWG cable, your voltage drop will be 0.02 VDC (multiplied by 20, you get a total voltage drop of 0.4 VDC). This illustrates that at 10 ft. away from the battery and with large cables, you can expect voltage drop. Again, try to keep cable length to a minimum and use the maximum gauge cable possible. **Xantrex recommends** the following cables for optimum inverter performance (apply to both 120 V and 230 V versions).

- 1000/12: #0 AWG or 55 mm²
- 1000/24: #6 AWG or 13 mm²
- 1800/12: #4/0 AWG or 110 mm²
- 1800/24: #2 AWG or 34 mm²

Also, use only high quality copper wiring and keep cable length short, a maximum of 3–6 ft.

Xantrex, in researching the requirements for inverter use in different markets, provides the following table that outlines the minimum DC cable size and maximum fuse/breaker size allowed by different regulatory bodies in the U.S. There may be other codes and regulations applicable to your installation:

Model	Marine Installation (1)		RV Installation (2)		Residential Installation (3)	
	Wire AWG	Fuse (A)	Wire AWG	Fuse (A)	Wire AWG	Fuse (A)
1000 12 V 1000i 12 V	#4	175	#4	150	#1	150
1000 24 V 1000i 24 V	#8	90	#8	90	#6	70
1800 12 V 1800i 12 V	#1	300	#1	225	4/0	250
1800 24 V 1800i 24 V	#6	100	#4	150	#2	125

¹ Based on ABYC Recommended Practice E-9, 75°C wire

² Based on NFPA 70, Article 551, 90°C wire

³ Based on NFPA 70, Article 240 and 310, 75°C wire

Table 4. DC wire sizes and inline fuse requirements



CAUTION
Clean battery terminals before making connections. Wear eye protection to keep corrosion from coming in contact with eyes.

To make DC wiring connections:

1. Before making any connections, route the positive and negative battery cables directly to the DC connection terminals on the Prosine Inverter. Slide the plastic terminal connector covers (boots) over the positive and negative cables (the red boot slides on the positive cable and the black boot slides on the negative cable). Do not route the cables through an electrical distribution panel, battery isolator, or other device that will add additional voltage drops

except for the required fuse or breaker on the positive battery terminal. Install the inverter so that the battery wire length is as short as possible. The connectors on the Prosine Inverter are designed to fit up to 250 MCM crimp-on ring terminals (either AMP or ILSCO) or box connectors (these tighten on connected cable using a set screw). Note, the coloured terminal covers (boots) fit much better with crimp-on ring terminals, and these are recommended over the box connectors.

2. Neatly cut the cables to the correct length and strip enough insulation to properly install the ring terminals or connectors. Attach the terminals to both cables using the crimp tool recommended by the manufacturer of the ring terminals. There must be no stray wire strands protruding from the terminal. Connect the terminal on the positive cable to the positive battery connector (stud) on the inverter and tighten with a wrench to a torque of 9–10 ft-lbs (11.7–13 Nm). Test that the cable is secure and is connected to the correct positive terminal.
3. An inline fuse between the Prosine Inverter and the battery is required by regulations for all installations. Again, refer to Table 4 for examples of correct fuse sizing for some regulations. This fuse protects your battery and wiring in case of an accidental short circuit during installation of the inverter or later damage to the wiring. The fuse and fuse holder need to be installed in the positive side of the DC circuit, as close as possible to the batteries and within the distance specified by the applicable installation code. Ensure all other power and ground connections have been made to the Prosine Inverter before connecting the DC cables to the batteries.
4. Connect the cable from the POSITIVE connector on the Prosine Inverter to the POSITIVE (POS +) terminal on the fuseholder. Observe the polarities carefully while performing the installation and do not reverse the polarities. Route both cables before making any connections.

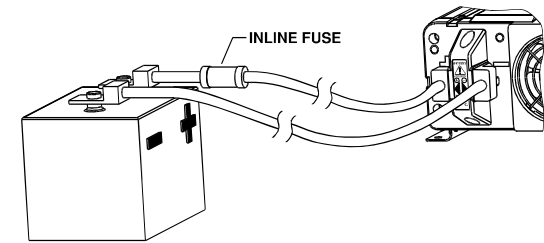



Figure 4. Battery Connections



CAUTION
An inadvertent reverse polarity connection may cause damage to the Prosine Inverter and it will require servicing (internal fuse will open). Before making the final DC connection, observe polarities to ensure that the wiring is correct.

5. Connect the DC NEGATIVE cable to the NEGATIVE (NEG -) terminal on the battery. Next, connect the cable to the negative terminal on the inverter. The connection to the negative terminal of the Prosine Inverter should be the last connection made. A spark when making this final connection is normal.



WARNING
Make sure all the DC connections are tight (torque to 9–10 ft-lbs, 11.7–13Nm). Loose connections will overheat and could result in a potential fire hazard.

6. For residential installations, a DC wiring enclosure is required to cover the DC connections. Contact Xantrex or your distributor for this part. For non-residential installations, slide the rubber terminal boot covers up the cable and over the terminal connections.

DC Grounding:

The Prosine Inverter has a lug on the rear panel labeled Chassis Ground. This lug is used to connect the chassis of the inverter to your DC ground as is required by regulations for some installations. Depending on where the Prosine Inverter is installed, follow the instructions below that correspond to your installation location.

Recreational Vehicle Installations Use #8 AWG or larger copper wire (green if insulated) and secure it to the chassis ground lug as well as the grounding point in your vehicle (usually the chassis).*

Marine Vessel Installations ABYC's recommended practices require that the chassis ground wire have the same current carrying capacity (ampacity) as the DC input cables. Using 90°C wire, the following wire sizes meet this requirement.**

Model	Wire Size (AWG)
1000/12 V	#6
1000/24 V	#10
1800/12 V	#2
1800/24 V	#6

Residential Installations The chassis of the Sine Wave Inverter must be connected to the system's DC grounding point. Use copper wire and secure it to the chassis ground lug and your DC ground point.***

Model	Wire Size (AWG)
1000/12 V	#6
1000/24 V	#8
1800/12 V	#4
1800/24 V	#6

* Based on NFPA 70, article 551-20(c)

** Based on ABYC A-25 and E-9

*** Based on NFPA 70, article 250-122 and 690-45

3. Prosine Inverter Operation

This section details how the unit functions as an inverter, provides information on the control panel, and describes operating limits for inverter operation.

3.1 Principles of Operation

The Prosine Inverter converts power from the batteries in two stages. The first stage is a DC-to-DC converter, used to raise the low voltage DC input to high voltage DC. The second stage is the actual inverter stage, taking the high voltage DC and converting it to a precise, true sine wave AC output.

The DC-to-DC converter stage uses modern high frequency power conversion technology that eliminates the bulky, low frequency (50/60 Hz) based transformers found in inverters using older technology. The inverter stage uses advanced power semiconductors that provide excellent overload capabilities.

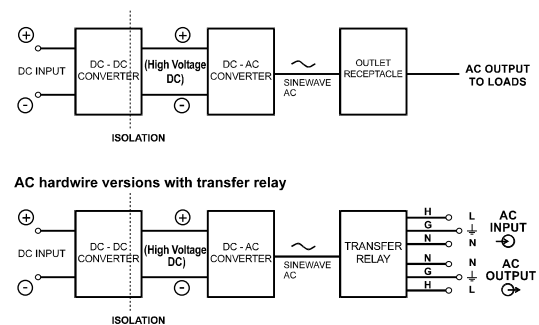

Figure 5. Principles of Operation

3.2 Output Waveform

The AC output waveform of the Prosine Inverter is a "true sine wave" with typically 1% Total Harmonic Distortion (THD). Figure 6 illustrates the output waveform from the inverter. This waveform is nearly identical to your utility-supplied power and in some

cases where utility power is poor, the Prosine Inverter delivers cleaner, more precise AC power.

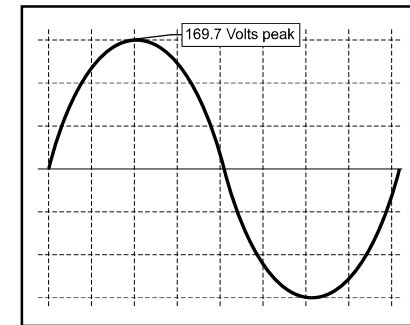

Figure 6. True sine wave output (120 V AC Model)

There are many advantages of true sine wave over other wave forms delivered by other inverters:

- AC powered equipment is designed to operate with true sine wave. Many loads will perform better when connected to the Prosine Inverter.
- motor loads start easier
- reduced stress on surge protection circuitry within the equipment means potentially longer equipment life

Many advantages of true sine wave are also due to the absence of the sharp-rising edges of waveforms prevalent in either modified sine wave or square wave inverters. Some of these advantages are:

- reduced interference in audio or electronic equipment, especially those that use less complex internal power supplies
- significantly reduced in-rush current into capacitive loads and reduced stress on the output devices of the inverter, potentially lengthening equipment life
- motor loads generally operate cooler and quieter without the extra harmonic distortion generated by a modified sine wave.

3.3 Control Panel

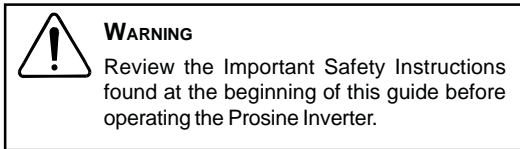

Once the Xantrex Prosine Inverter is properly installed and connected to batteries, it is ready to begin delivering AC power to your loads. The control panel is the interface between you and the inverter. This section describes the features of this panel and is followed by other sections that contain inverter operating information.

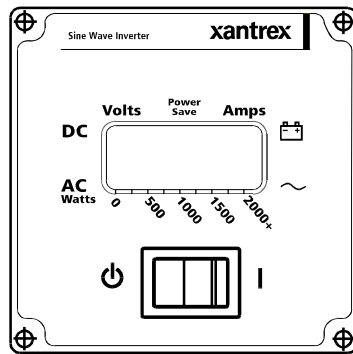

Figure 7. Control Panel

1. INVERTER O/I : this switch turns the Prosine Inverter either ON (**I**) or to BYPASS-state (**O**). It is also used to enable or disable POWERSAVE mode during the power-up sequence. When in the (**O**) position, models equipped with a transfer relay will be in the BYPASS mode, where incoming AC power is passed through to the load. The switch controls the output of the inverter with models equipped with AC outlets and does not control the output on hardwire units equipped with the transfer relay option.

2. LIQUID CRYSTAL DISPLAY (LCD): displays input current from the battery and battery voltage numerically. A multi-segment bar graph displays actual output power in watts from the inverter when a load is being operated.

3. MULTI-POSITION MOUNT: the control panel is designed so it can be removed and re-attached to the chassis in 90° increments depending on the mounting orientation of the inverter itself. The panel can also be removed entirely from the unit and mounted remotely, with the purchase of the optional Interface Panel.

4. FAULT CONDITION DISPLAY: should a fault occur, the error will immediately be displayed. An audible alarm sounds and the back-lighting of the display will flash to draw attention to the fault condition (see Section 5.1).

To operate the Prosine Inverter:

1. Turn the unit ON by moving the rocker switch on the control panel to (**I**) position. The following information will be displayed (upon each power-up), identifying the type and configuration of your Prosine Inverter:

- Model number (1000 or 1800 watt)
- Input Voltage, Output Voltage and Frequency configuration
- POWERSAVE mode OFF (factory set default)

Following the display of this information, the control panel then defaults to the standard display information of input voltage, input current and output power. When a load is connected, the output power (watts) is displayed in bar-graph form.



Figure 8. Control Panel Screen Sequence

Once the standard display screen is shown, the Prosine Inverter is ready to deliver AC power to your loads. You can now plug in a load to the front outlet of the unit, or, for those hardwire versions, into an outlet connected to the AC output of the inverter. The loads should operate from the inverter as they would from utility power. Section 3.5 explains the operating limits for the Prosine Inverter.

3.4 Prosine POWERSAVE Mode

Your Xantrex Prosine Inverter has a function mode called POWERSAVE. This “sleep” mode shuts off much of the power control circuitry of the inverter as well as the display back-lighting, reducing the stand-by current draw considerably. With this mode enabled, the unit draws approx. 1.5 W while powered up but with no load on the inverter. The Prosine Inverter detects the presence of a load by sending out pulses approximately once every 2.5 seconds. Full output power is available with the detection of a load. The unit will remain in POWERSAVE mode if the load it detects is less than 10 W for the 1000 model and less than 20 W for the 1800 model. This is a factory set search mode setting and cannot be changed.

You would want to enable POWERSAVE mode if the inverter is only being used periodically to power loads. This allows the inverter to draw less power from the batteries during non-use periods. If the inverter is being used frequently and your batteries are being recharged during inverter use (e.g. vehicle alternator), or soon after inverter use, you can leave POWERSAVE disabled.

Your inverter is factory default set to POWERSAVE OFF. To enable the POWERSAVE mode, follow these steps:

1. Turn the Control Panel switch to (**O**) position
2. Switch the unit back to (**I**) position. You will see the power-up information sequence being displayed as described previously.
3. When the Control Panel displays “POWERSAVE OFF” turn the switch to (**O**) position, wait for

approximately three seconds, and then turn the switch back to (I) position. “POWERSAVE ON” will now be displayed during the start-up sequence and when the normal state display appears, a small pointer will be visible, indicating POWERSAVE mode is enabled. Repeat the same procedure for disabling POWERSAVE mode.

3.5 Inverter Operating Limits and Protection Features

Power Output: The Prosine 1000 Inverter will continuously deliver 1000 watts and the Prosine 1800 delivers 1800 watts continuously. The following table displays the continuous and peak current ratings as well as surge rating, depending on the model:

Model	Continuous AC Output Current Rating	Peak AC Output Current Rating	Surge Rating (max. watts delivered for 5 seconds)
1000	8.3 A	25 A	1500
1800	15 A	45 A	2900
1000i	4.3 A	11 A	1500
1800i	7.8 A	20 A	2900

Each unit above will be able to operate all AC loads rated at or below these power ratings. Some high-horsepower induction motors used in pumps and other motor-operated equipment require very high surge currents to start and the Prosine Inverter/battery combination may have difficulty starting these loads. If you have problems with certain loads, ensure that battery connections are solid, your DC cables are appropriately sized, and that the battery is of sufficient capacity and fully charged.

Input Voltage: The Prosine Inverter operates from an input voltage ranging from:

- 10 to 16 VDC for 12 V models
- 20 to 32 VDC for 24 V models

Peak performance for these inverters occurs when DC input voltage is in the range of 12 volts to 15 volts for 12 V models and 24 volts to 30 volts for 24 V models. The Prosine Inverter will indicate high and low DC voltage conditions as follows:

Model	DC Input over voltage alarm	DC Input over voltage shut down	DC Input under voltage alarm	DC Input under voltage shut down
12 V models	15.8 VDC	16.0 VDC	10.5 VDC	10.0 VDC
24 V models	31.6 VDC	32.0 VDC	21.0 VDC	20.0 VDC

The over-voltage protection and shutdown protects the inverter against excessive input voltage, should the unit be connected to a higher voltage than it is designed for (up to 35VDC—higher voltages may cause damage). Low input voltage shutdown protects your battery from being over-discharged. The inverter requires a manual reset to re-start after shutdown from either high or low input voltage. Turn the power switch to (⏻) and then back to (I) to re-start the unit.

Output Overload Protection: A short circuit may be applied to the output continuously without damage to any internal components. The Prosine Inverter will shut down in less than five seconds when the output falls 10% below the nominal voltage as a result of current limiting.

AC Backfeed Protection: Although the Prosine Inverter has been designed to withstand incoming AC at the AC output, this is only a safeguard and continuous AC backfeed could lead to inverter damage. Avoid inverter damage by double checking the AC input and output wiring on hardwire configured models before applying power and by understanding your source of AC and where power from the source leads to (e.g. do not plug a live extension cord into the AC outlet of the inverter).

Input Reverse Polarity Protection: The internal circuitry of the Prosine Inverter is protected by an internal, 32 V, fast-blow fuse as follows:

Model	Mfg & Model
1000 - 24 V 1000i - 24 V	Littelfuse/Gould CNN80 or Bussmann ANN80 rated 80 A
1800 - 12 V 1800i - 12 V	Littelfuse Mega 225 A
All others	Littelfuse Mega 125 A

This fuse is only replaceable by qualified service personnel. In many reverse polarity conditions, this fuse will protect internal circuits, however, certain high voltage/current situations may cause internal damage.

4. Testing

The following simple test procedure should ensure that the inverter is connected and installed properly.

To test the Prosine Inverter:

1. Double check all wiring terminals on the inverter to observe correct polarity and secure connections.
2. Turn rocker switch to (I) position.
3. Observe the power-up sequence on the display. The normal-state inverter display of input current and input voltage should come up.
4. Plug a test load (e.g. a light bulb) into the outlet of the Prosine Inverter. The load should function normally. Observe the output power bar graph—it should increase with load demand.
5. For hardwire and transfer relay-equipped versions, plug a load into the AC output leg of the inverter while input AC is available. Remove input AC. The load should still operate normally. Replace the source AC input power and again, the load should operate normally, indicating proper installation and function of the transfer relay.
6. Repeat test 4 or 5 with the inverter in “POWERSAVE” mode.
7. The Prosine Inverter is now ready for operation.

5. Troubleshooting Guide



WARNING

Do not open or disassemble the Prosine Inverter. See Section 6 for instructions on obtaining service for the inverter. Attempting to service the unit yourself may result in a risk of electrical shock or fire.

This section describes potential installation and configuration problems and solutions, including fault conditions and indicators.

5.1 Fault Conditions and Indicators

The following fault conditions are displayed on the control panel along with an alarm sound and blinking LCD back-light.

Control Panel Indication	Fault Condition	Solution
HIGH BATT SHUTDOWN	Battery voltage too high	Check for fault with battery charging system. Manually reset inverter by turning switch to (⏻) then to (I) again.
LOW BATT SHUTDOWN	Battery voltage too low	Charge battery. Manually reset inverter by turning switch to (⏻) then to (I) again.
OVERLOAD SHUTDOWN	Battery current too high, probable AC overload	Reduce load on inverter.
OVERTEMP SHUTDOWN	System over-temperature	Improve ventilation and cooling and/or reduce load on inverter.
SYSTEM SHUTDOWN PS_FAULT SHUTDOWN DC-DC SHUTDOWN	Overload or system hardware fault	Ensure all loads are disconnected. Try to reset inverter by switching to (⏻) and then to (I). If unit still does not operate contact your distributor/merchant/retailer or Xantrex for service/warranty replacement.

The table below provides some troubleshooting tips:

Problems and Symptoms	Possible Cause	Solution
No output voltage and control panel reading 10.0 VDC or lower (20.4 VDC on 24 V models).	Low input voltage shutdown.	Recharge battery, check connections and cable.
No output voltage, no voltage indication.	Inverter switched to (⏻).	Turn Inverter power switch to (I).
	No battery power to inverter.	Check wiring to Inverter. Check battery fuse.
	Reverse DC polarity connection —internal fuse open.	Have qualified service technician check and replace fuse (correct replacement fuse noted on inside of unit). Observe correct polarity.
No output voltage and control panel reading 16.0 VDC or higher (32.0 VDC on 24 V models).	High input voltage shutdown.	Make sure the Inverter is connected to correct battery voltage Check regulation of charging system.
Low battery warning on all the time. Voltage indicator below 11.0 VDC (22.0 VDC on 24 V models).	Poor DC wiring.	Use proper cable and make solid connections.
	Poor battery condition.	Charge battery or use new battery.

Performance Graphs

Power Derating Curve

As with all inverters, the amount of continuous power that the Xantrex Prosine Inverters can deliver without overheating is limited by ambient (surrounding air) temperature. The following “Power Derating Curve vs. Temperature” illustrates the relationship between power output and ambient temperature.

Operating the unit above this temperature will result in thermal shutdown or decreased performance. At input voltages less than 12 V or 24 V, the unit runs warmer which will cause thermal shutdowns at temperatures below these ambient temperature guidelines.

Operating the unit in conditions outside the power and temperature limits (above and to the right of the derating curves) will result in thermal shutdown and/or significantly decreased performance. In addition, operation in this range is outside of the ratings covered by the product’s regulatory approvals.

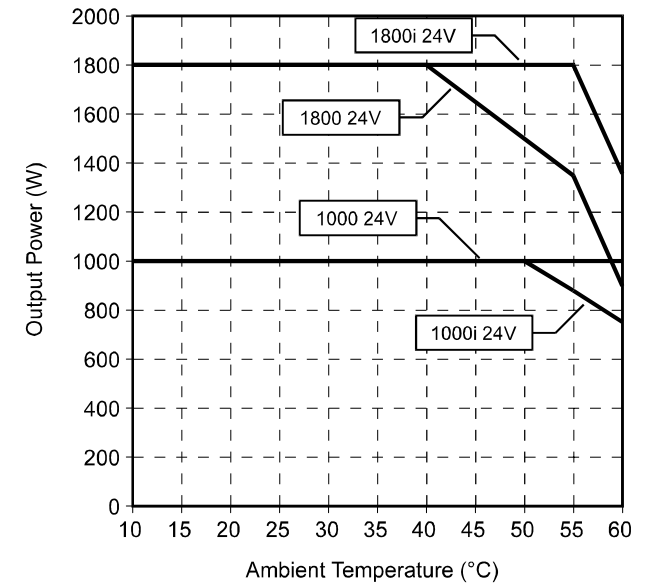
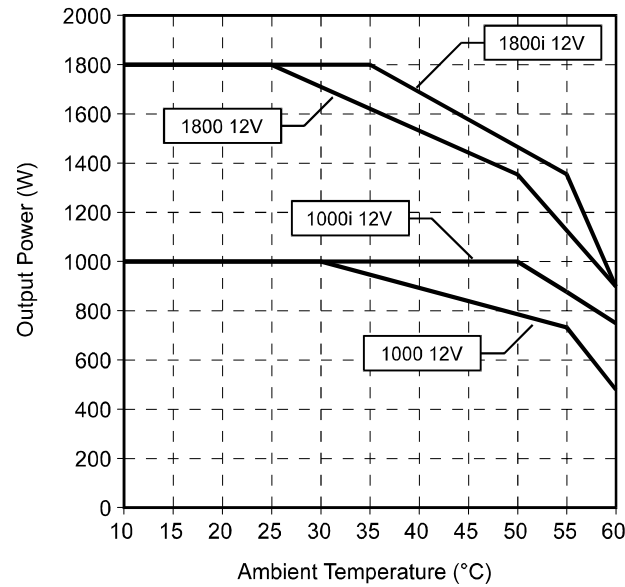

Efficiency Curve

The efficiency rating of the Xantrex Prosine Inverter indicates what percentage of DC power is converted to usable AC power at given power output levels. The higher the rating, the less power is lost in the way of heat from the inverting process. Xantrex Prosine Inverters have an extremely flat efficiency curve over much of their operating range so less battery power is wasted, whether operating at low power levels or higher power levels. The following measurements were conducted at 12 V and 24 VDC input voltage on 120 V, 60 Hz and 230 V, 50 Hz inverters.

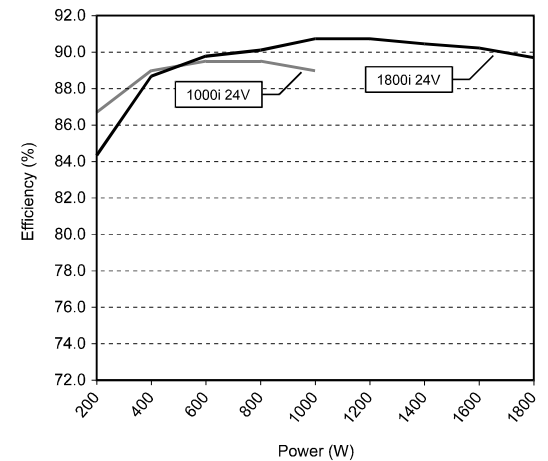
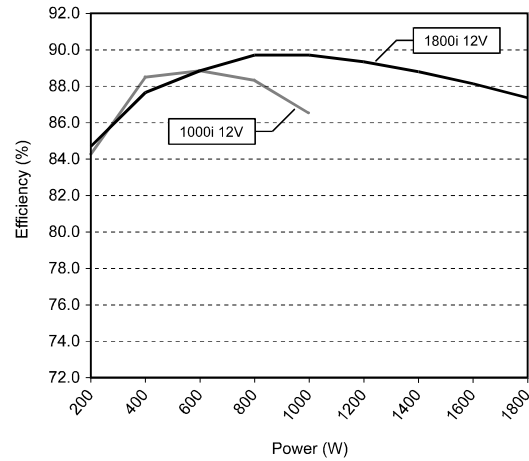
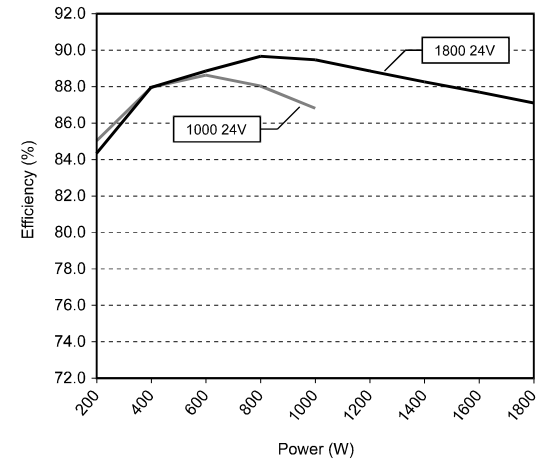
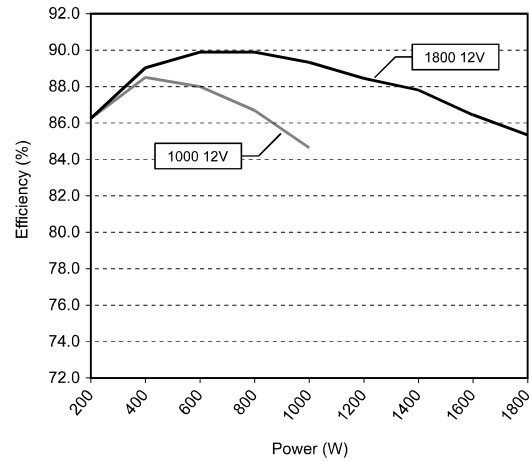

Specifications

	1000	1800	1000i	1800i
Continuous output power	1000 W	1800 W	1000 W	1800 W
Surge rating (5 seconds)	1500 W	2900 W	1500 W	2900 W
Peak output current	25 A	45 A	11 A	20 A
Peak Efficiency	89%	90%	90%	
No load draw, search mode	<1.5 W		<1.5 W	
No load draw, idle mode	<22 W		<22 W	
Output frequency	60 Hz ±0.05%		50 Hz ±0.05%	
Output waveform (resistive load)	Sine Wave (<3% THD, 1% TYP.)		Sine Wave (<3% THD, 1% TYP.)	
Input voltage range 12 VDC/24 VDC models	10-16 VDC / 20-32 VDC		10-16 VDC / 20-32 VDC	
Output Voltage (at no load)	120 VAC RMS ±3%		230 VAC RMS ±3%	
Output Voltage (over full load & battery voltage range)	120 VAC +4%, -10%		230 VAC RMS +4%, -10%	
Low Battery Cut-out 12 VDC/24 VDC models	10 VDC / 20 VDC (5 sec. time delay, 10.5 Vdc warning)		10 VDC / 20 VDC (5 sec. time delay, 10.5 Vdc warning)	
High Battery Cut-out 12 VDC/24 VDC models	16 VDC / 32 VDC		16 VDC / 32 VDC	
Protection	Automatic overload, short circuit, over-temperature, over-voltage, under-voltage, reverse polarity (fuse), AC backfeed		Automatic overload, short circuit, over-temperature, over-voltage, under-voltage, reverse polarity (fuse), AC backfeed	
Transfer Relay Rating	15 A (on hardwire/transfer relay models)		10A (on hardwire/transfer relay models)	
Transfer Time AC to Inverter and Inverter to AC	Max. 2 cycles (typically 1 cycle); <2.5 seconds with POWERSAVE on		Max. 2 cycles (typically 1 cycle); <2.5 seconds with POWERSAVE on	
Regulatory Approvals Safety	CSA/NRTL Certified to CSA 107.1, UL 458		Low Voltage Directive 2006/95/EC EN 50178:1997	
EMC			EMC Directive 2004/108/EC - EN 61000-6-1:2007 - EN 61000-6-3:2007 Automotive EMC Directive 2004/104/EC as amended by 2005/83/EC Testing ("New" Automotive Directive)	
Designed to meet	ABYC E8, E9, A25, KKK-A-1822D available upon request			
Dimensions (H x W x L)	4.5" x 11.0" x 15.4"		115mm x 280mm x 390mm	
Weight	14.5 lbs / 6.5 kg	16.5 lbs / 7.5 kg	6.5 kg	7.5 kg
Operating Temperature	32 °F (0 °C)–140 °F (60 °C)		0 °C–60 °C	
Storage Temperature	-22 °F (-30 °C)–158 °F (70 °C)		-30 °C–70 °C	